

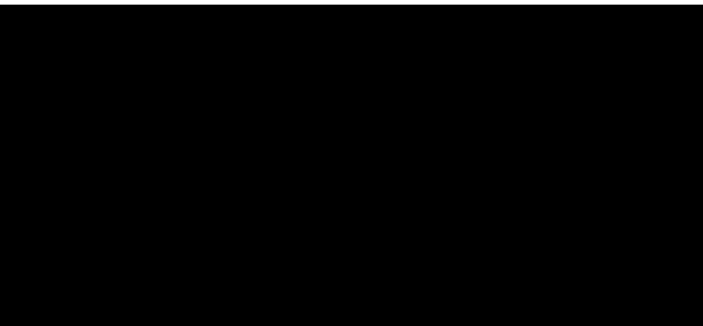

GREAT LAKES

DATA RACKS & CABINETS

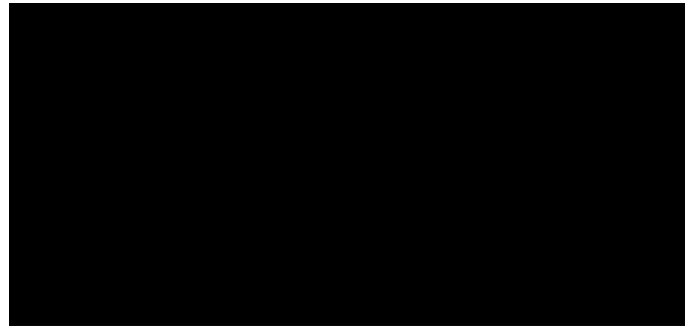

GREATCABINETS.COM
1.866.879.4522

STARTING AT SQUARE ONE

WE RACK YOUR WORLD.

You've got important stuff to protect. We build the products to do that. And nobody does it faster. Or makes it easier. Or just the way you want.

From innovative data rack systems and wall mounts to impenetrable security panels and cabinets. Plus, cool cable management solutions. Custom and stock products. And then there's this thing we call SEAL®.

Check out our new products. Test us on our improved processes. While you're at it, tell us what you think about our new logo.

We're Great Lakes Data Racks and Cabinets. And we rack your world.

***“Fast, flexible, easy –
that’s us in three words.”***

Jonathan Markley - President



GreatCabinets.com

We rack your world.

TABLE OF CONTENTS

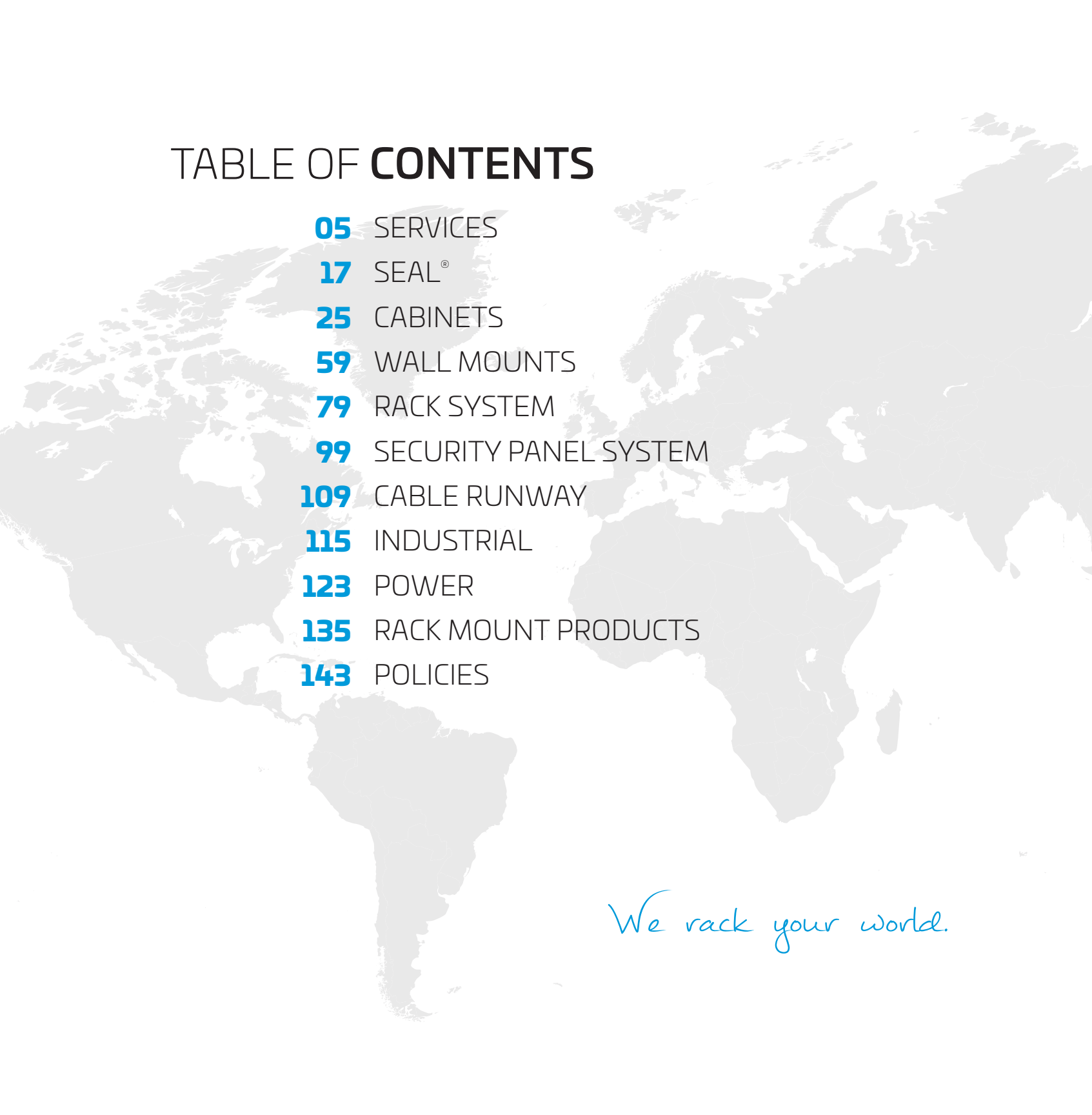

05	SERVICES
17	SEAL®
25	CABINETS
59	WALL MOUNTS
79	RACK SYSTEM
99	SECURITY PANEL SYSTEM
109	CABLE RUNWAY
115	INDUSTRIAL
123	POWER
135	RACK MOUNT PRODUCTS
143	POLICIES

We rack your world.

SERVICES

We rack your world.

FAST. FLEXIBLE. **EASY.**

That's right, you can have it all. When it comes to data center products, there's not much we can't do. It's how we rack your world.

Need a quote within the hour? No problem. Want to talk direct to our engineers? Sure thing. Need us to keep your made-to-order product in stock? You got it.

Security solutions. Stack integration and inventory. No-hassle shipping. Custom or stock cabinets. Cooling strategies.

Around the country, around the world, our team gets it done (well, with the help of some really cool robots).

“From the moment we take an order, we handle everything.”

Debbie Moyer - Director of Inside Sales



GreatCabinets.com

FAST SERVICES

YES,
YOU CAN HAVE IT ALL.

Have you heard? We build the best US manufactured data center products, but it's how we do it that matters more. It's all in the details.

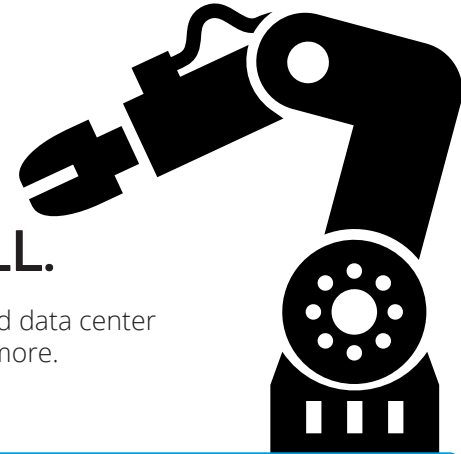

WE'RE FAST. FLEXIBLE. AND EASY.

HOW FAST IS FAST?



Fast Quotes

Whether you've picked a product off the shelf or want to build something unique from scratch. And like we said before, because everything is here in one place, we're not waiting on anyone for anything.



Fast Manufacturing

We have these automated robots manufacturing products. Whether it's making hundreds of a standard part, or swapping out programs to get started on your custom project—it's a huge time savings. The technology helps us fill the orders that hit our desks, but it's the incredible people on the shop floor making sure product is made in the most efficient and effective way. Every time.



Fast Shipping

From project start to installation, we're completely focused on your requirements. Including your delivery deadline. That's shipping in 24-48 hours on most items that we offer. But whether you order one of something... or a whole bunch more, we are working with your schedule.



QUICK FRIENDLY QUOTES



STATE-OF-THE-ART ROBOTIC TECHNOLOGY



NO MINIMUM ORDER



24-48 HOUR SHIPPING

HOW FAST IS FAST? YOU TELL US.

FLEXIBLE SERVICES

A LONG TIME AGO...

We realized a key to our success. Everybody likes options. And lots of them. So we got really good at being flexible. From customizing your rack or cabinet to how it's shipped to your site.

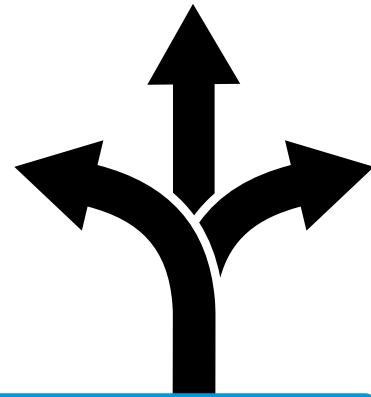

OPTIONS ARE ENDLESS

YEAH, WE'RE THAT FLEXIBLE.



Flexible Products

We've engineered our products to give you options - lots of options. Sort of like an erector set - our products can be configured just the way you want them. Pick the parts to build your own airflow, cable management, power, and security strategy and let us do the rest.



Flexible Designs

Take our almost world-famous FMP system - aka the Flexible Mounting Profile. It's a series of holes along the rack rail. Outside the mounting pattern. Install cable rings, cable posts, cable fingers, cable managers, patch panels, power strips, and on and on. Find it on our cabinets, racks, and industrial products.



Flexible Integration

Then there's our STACK integration service. We'll set up one of our off-the-shelf products with the accessories you want. Need your favorite PDU or third-party product installed? Have it dropped shipped to us, or we'll source it with the rest of your Great Lakes order. Product is ready when it gets to your door. You save time and freight costs. Plus, you get to skip installing all those cage nuts.

FLEXIBLE IS OUR MIDDLE NAME.

FLEXIBLE MOUNTING PROFILE - THE OPTIONS ARE ENDLESS

Cabinets. Racks. Industrial. It's a rail pattern across our product line that isn't just for cage nuts and screws. It's so much more.

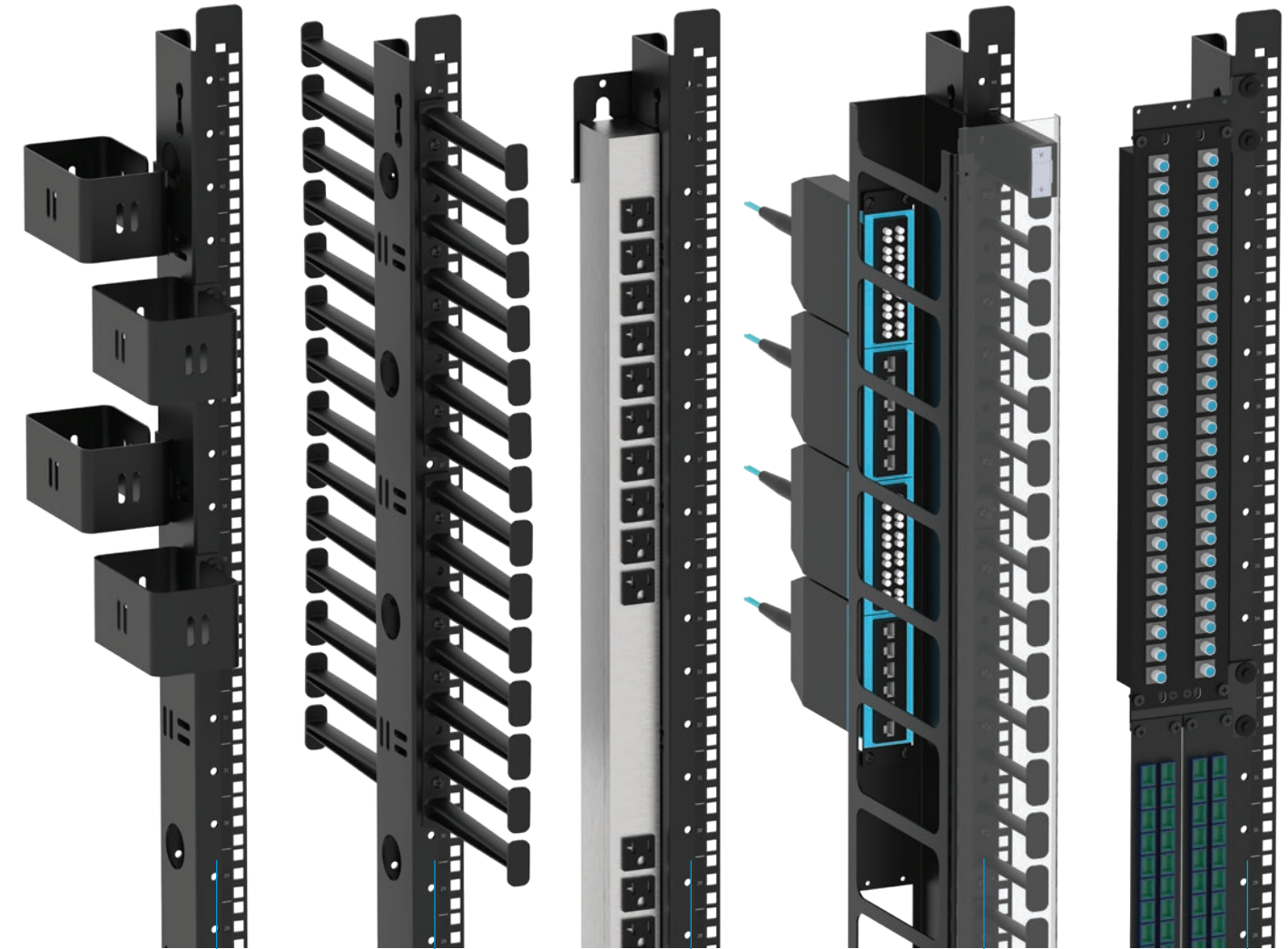

Rings
(CM-11)

Fingers
(CM-77)

PDU
(PSBKES-R-30)

Vertical Manager
(VCMK-84)

Zero-U Brackets
(ZR2)

EASY SERVICES

WELL, THIS IS **EASY!**

A human will answer your call immediately! We let you know exactly where and when your product will be delivered. And our no-hassle shipping policy means we will replace any order that doesn't arrive in perfect condition. Boom!
We were on this easy thing way before the Staples button.



IT'S ALL ABOUT ENSURING YOUR EXPERIENCE IS HASSLE-FREE.

JUST LIKE THAT!

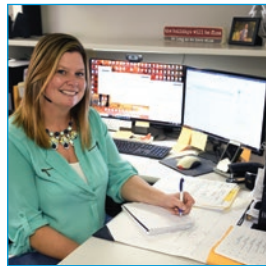

Easy Customer Service

A friendly voice will answer your call from 8 a.m. to 8 p.m. (EST). You'll always be directed to the person that can help you the most, and we'll get you answers as fast as we can. Say you want to add or swap some parts on your cabinet. Every product we make has a serial number that IDs it and how it's configured. Call us and we'll know exactly what will work. That was easy.



Easy Shipping

We've got a method for you. **Dock-to-dock**—carrier pulls up, unloads, leaves...in and out in a flash! Don't have a dock? **Liftgate** service delivers freight to ground level. Standard **Inside Delivery** brings freight to a designated area without physically lifting the cabinet. **White Glove** Inside Delivery is up the steps/elevator/stairwell, or anywhere you need it. White glove even covers packaging removal and disposal. Now that was...well, you know.



Easy Freight Protection

How about our "No-Hassle Freight Protection" that gives you 72 hours to report any damages? Find something wrong? No worries. Give us a call and we'll take all the responsibility to get you new parts. No questions asked. No cost to you. Just specify 'Pre-pay and Add' when you order—it shows up on your quote and you know you're covered. Easy.



SHIP HAPPENS!

We've been shipping racks around the world for over 35 years. Let our team of experts help protect it along the way. Great Lakes "No Hassle Freight Protection" will ensure your product gets to its destination intact and if for any reason it doesn't — a replacement goes out, no questions asked.

FAST. FLEXIBLE. EASY. THAT'S HOW WE RACK YOUR WORLD.

CUSTOM SERVICES

DON'T SEE IT ON THE RACK?

We can fix that. Narrow closet. Low ceiling. Brownfield site. New construction. Data center in a mountain. We've been making special products for unique spaces for more than 35 years.

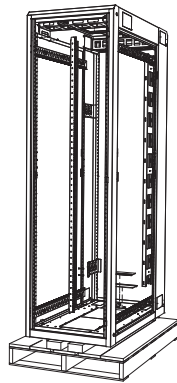

WANT A WALK-IN CLOSET BUT DON'T HAVE THE SPACE? LET'S TALK.

HANG WITH US.



Your Modifications

We know that sometimes product isn't perfect for you. If our cabinets, wall mounts, and racks almost meet your need, let our design experts make modifications so it's better for you. Bigger or smaller. More or less knockouts. Different color. When it's based off of existing product, you get a custom product faster. At a reduced cost.



Your Retrofit

Already have product in place that didn't come from Great Lakes? No problem. Engineers can create retrofit solutions to improve the products you already have onsite. Upgrade the door, create better cable management, completely enclose rack mount equipment that isn't secure. We can do it without causing you downtime. No downtime means there's more uptime.



Your Design

Or ours. If the flexibility of our standard product just won't do, let's create something together. We can combine your requests (because no one knows your needs better than you) with our 35 years of design experience to create the best product for the job. A custom datacom product. Custom industrial product. Or any custom metal product...after all, we are metal fabricators.

CUSTOM SOLUTIONS TO FIT YOUR WORLD.

CUSTOM OPTIONS - LET US TAILOR A PRODUCT FOR YOU

A modification. A retrofit. Or from scratch. In six weeks or less. It's just that fast, flexible and easy!

Top Cable Trough
Bigger trough to accommodate the increased cabinet size

Reinforced Mounting Points
Modified hole pattern on top of the cabinet to support a two tier ladder rack system

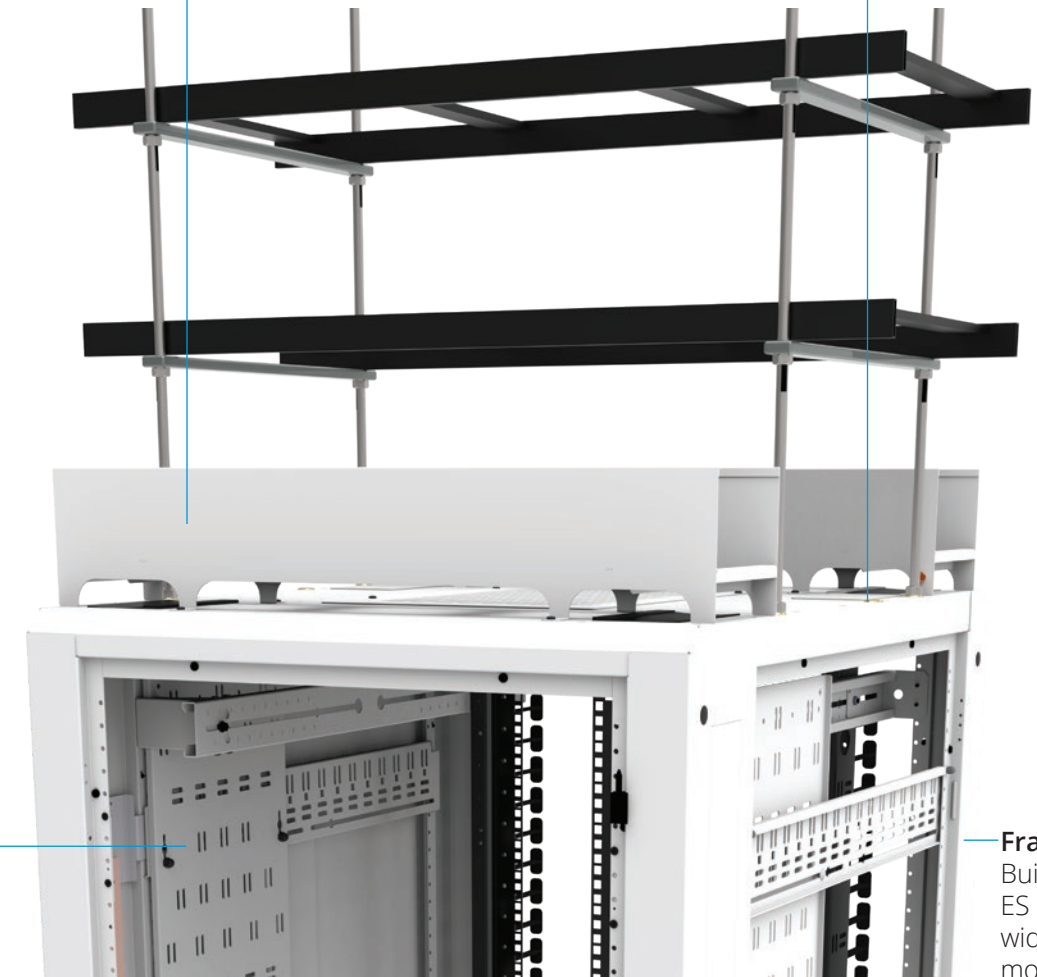

Wider Cable Bars
Two times the size of a standard cable bar for high density cable bundles

Frame Size
Built like our popular ES cabinet, but a tad wider for unique rack mount equipment

CUSTOM TO STANDARD

Custom product that is the requirement for large projects and future orders can become part of our standard product portfolio and in many instances, can be stocked on the warehouse floor!

COOL SERVICES

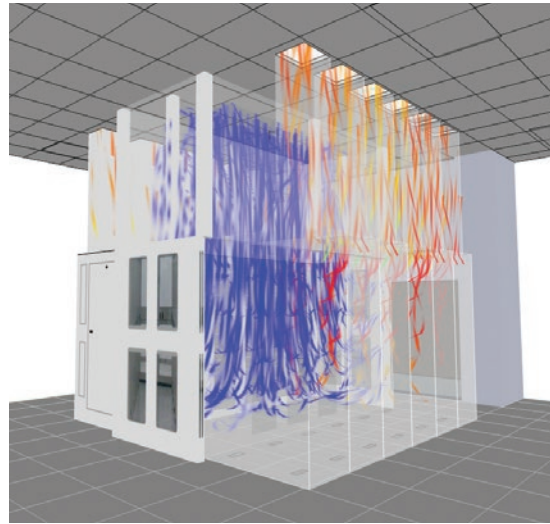
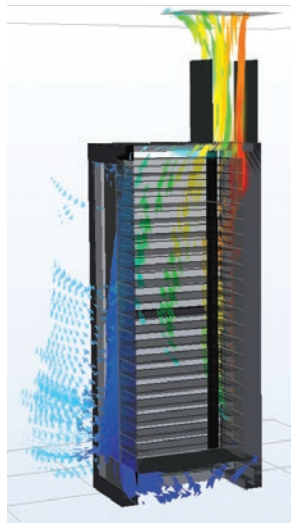

NEED A TOUCH OF COOL?

We definitely have that! We can help you make and deploy an airflow strategy for your space. And we aren't just blowing hot air. From a single cabinet to hundreds deployed with aisle containment. There's a solution to increase cooling capacity and decrease PUE.

CFD modeling – Computational Fluid Dynamics – let us help you make “cool” decisions.



Cost Efficient.

Test out new layouts and reduce capacity planning mistakes (hey, it happens). Eliminate the possibility of rework while saving time and money.



Energy Efficient.

Identify areas that need airflow segregation and implement best practices. Fix hotspots. Improve cooling.

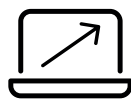

Uptime Efficient.

Eliminate the hotspots and you eliminate the possibility of overheating and shutdown. Running 24/7/365... that's your goal.

We can analyze a model one time. Or as a continuous service, we can analyze and reanalyze so you have instant access to answers all the time. Point by point. Zone by zone. Eliminating downtime and saving you money.

A WAREHOUSE FULL OF SERVICES. THAT'S HOW WE RACK YOUR WORLD.

We rack your world.

THREATS **ELIMINATED.**

How good is SEAL® security? Scary good. Like 35-years-of-engineering good. And the final solution when you need to eliminate physical threats to your critically sensitive equipment.

This is next generation protection. Sophisticated. Virtually impenetrable. Peace of mind ready to be integrated in our security panels, wall mounts and cabinets.

SEAL technology boasts features like access control with multi-factor authentication, handles with a three-point latch system, internally secured panels, invisible (as in you can't tell where it's at) hardware and concealed cables. Plus, a when-where-why audit trail to answer any question.

There's data center security. And then there's SEAL.

“SEAL is a solid security investment.”

Melissa Campbell - Regional VP



GreatCabinets.com



SERIOUS DATA SECURITY. REAL SERIOUS.

That thing that always happens to the other guy? You know, when some disgruntled employee (or worse, the guy that was fired yesterday who someone just let in the back door) decides to turn your worst data center nightmare into reality.



WITH SEAL ON YOUR SIDE, YOU'RE ALREADY TWO STEPS AHEAD. MAYBE THREE.

SEAL stands for Security Enclosure All Levels. And we mean exactly that. Serious data security. The ultimate protective barrier for your physical data assets.

SOME STATISTICS TO CONSIDER:



55%

of all insider attacks are focused on file servers. That makes them the most vulnerable IT asset you have.



265,000,000

is the potential dollars lost due to a data breach at one healthcare provider's data center. Count the zeros... that's a lot of money walking out the door.



95 MINUTES

is the average amount of data center downtime caused by an unplanned outage. Insider attacks and outages will rise. And time is expensive when a minute costs nearly \$9,000.

We could go on, but you get the point. The threat is real. It's up to you to put a solution in place.

SEAL THE DEAL, SO TO SPEAK.





Delay, Deter & Detect

SEAL products are the best on the market. Engineered to delay, deter and detect unauthorized entry to your sensitive data equipment.

It's the perfect marriage of our high quality indoor or outdoor data enclosures with sophisticated intelligent components. Joined as one to eliminate threats and give you peace of mind.

Multi-factor entry authentication?
Check.

Single access point to multiple cabinets?
Check.

Real-time monitoring and reporting from anywhere?
Check.

You see where we're going with this...you need to **"Check SEAL out."**



AND THEN... THERE'S THE HANDLE. **THE SEAL HANDLE.**

We wanted to take data security to the next level. So we started with the most accessible point of entry—the door handle. Handles on cabinets. Handles on wall mounts. Handles on your existing product. Add intelligent access control handles to any of these products.

Access control handles let you decide who gets access to your data equipment and how they get access: single or multi-factor authentication. Then it tracks all activity: real-time monitoring, report generation, user and equipment logs.

Still not cool enough for you? You can manage all this from your mobile phone or tablet.

WHO'S RACKING YOUR WORLD NOW?



	SEAL-R1000	SEAL-R3000KP	SEAL-DDL	SEAL-DCL	SEAL-TLPP	SEAL-TLTD
Authentication Method	Depends on Customer's Configuration	RFID card + PIN	RFID card + finger	RFID card + PIN	PIN	Touch display code lock
Access Control Software	3rd Party Software or Mfr. Suite	Mfr. Admin. Suite	Mfr. Admin. Suite LENEL integrated partner	Mfr. Admin. Suite LENEL integrated partner	Mfr. Admin. Suite	Mfr. Admin. Suite
Cut Out Size	25 x 150 (mm)	25 x 150 (mm)	25 x 150 (mm)	25 x 150 (mm)	25 x 150 (mm)	25 x 150 (mm)
Key Features	- Easily integrates into an existing facility	- Well suited for many cabinets located in same location - Dual factor authentication - Connect 32 handles to a single IP address	- Well suited for cabinets located in different rooms - Dual factor authentication - High frequency card	- Well suited for cabinets located in different rooms - Dual factor authentication - High and low frequency cards	- Easy entry of a PIN over foil key board with optical response - Power supply by PoE - Grant up to 30 individuals access	- High definition color display - Easily integrates into an existing facility - Optional IP54 or IP65 rating

Listed handles are commonly installed. Additional handle options available; please contact Inside Sales.

STRATEGIC DEPLOYMENT

SECURITY SOLUTIONS

SEAL® DATA CENTER

SEAL cabinets with dual-factor authentication handles are a preventative measure to know “who done it” in this healthcare provider’s facility. Past incidents, regulatory industry standards and internal audit protocols urged the management team to implement a complete solution: monitor and prevent unauthorized entry; and instant access to an audit trail report.



UNIQUE CUSTOMIZATION

Unique application? No problem. This free-standing, under counter cabinet houses critically sensitive equipment in US classified locations. The cabinet segregates classified and nonclassified equipment. A gland plate brings RJ45 network cables to the outside of the cabinet. The cables can be quickly accessed for maintenance and upgrades while the cabinet itself remains locked to protect all classified equipment.



“SHROUD” OF SECURITY

When security is not a concern, open racks are often ideal for high density network applications. As ideology and compliance standards shift, security is now a necessity, including in this government organization. Custom sides and locking doors attach to existing racks to create a level of security at the cabinet level. No downtime was experienced in the making of this cabinet.



ISOLATED WALL MOUNTS

Wall mounts are strategically placed throughout a building (e.g. hallways, closets, stairwells) to extend a network’s reach. SEAL ready wall mounts can easily be equipped with intelligent access to create a more secure space in these medium- to high-traffic areas. And we mean easily equipped—the door requires no physical modifications to accept an access control handle.



We rack your world.

YOU WANT CHOICES.

We hear you. You want to know your options. Alternatives to the standard fare. You want to build out your data center your way. So at Great Lakes, we say, 'have at it.'

Maybe you're after the most secure cabinets on the market. Or cabinets that are highly configurable to meet evolving needs. How about cabinets for quick deployment, whether it's 1 or 100. And even cabinets that protect against seismic activity (who knew, right).

Of course, you want choices with cabinet options as well. Like flexible mounting systems. Cable management. And air flow technology. No worries, we've got several solutions for all.

And just because you want choices, doesn't mean you can't have it fast. Remember, we design, build and assemble all in the same place.

Data cabinets made functional, flexible and fast. There we go again, racking your world.

“What sets us apart is our ability to configure cabinets exactly the way you want.”

Bill Santucci - Director of Product Development



GreatCabinets.com



CABINET CHOICES



	SEAL	ES CABINETS	E CABINETS	L CABINETS	CL CABINETS	EZ CABINETS	NEMA 12K CABINETS	
Key Features	A nearly impenetrable cabinet with intelligent components	Most configurable cabinet for evolving data center needs	Extensive line of cabinets for use in small-to-large deployments	Ready-to-ship cabinet for swift deployment of one or hundreds	Distinct segregation/access control to each cabinet bay	Robust & accessory-rich cabinet to protect against seismic activity	Cabinet to protect equipment in harsh indoor environments	
RMU/Height (in.)	48 RMU / 91 44 RMU / 84	48 RMU / 91 44 RMU / 84	44 RMU / 84 37 RMU / 72 31 RMU / 60	24 RMU / 48 13 RMU / 30	47 RMU / 91 42 RMU / 79	14 RMU per bay (3 bay), 84"H 21 RMU per bay (2 bay), 84"H	44 RMU / 84 42 RMU / 79	45 RMU / 84
Width (in.)	32, 30, 24	32, 30, 24	29, 24	32, 24	30	30, 24	30, 24	
Depth (in.)	48, 42, 40	48, 42, 40	36, 32	48, 42	48, 42, 36	48, 42	42	
Usable Depth (in.)	46, 40, 38	46, 40, 38	34, 30	44, 37	46, 40, 34	46, 40	41	
Max. Rail Placement (in.)	35	35	34, 30	42, 35	45, 39, 33	35	34	
UL Rail Rating/Max. Static Weight (lbs.)	3300/4000	3300/4000	1500/2500	3000	1500/2500	1000/5000	4000	
19" Mounting Rails	- 3/8" sq. or #10-32 - Fully adjustable, front to rear - RMU markings - Flexible mounting profile along rail - Lacing points	- 3/8" sq. or #10-32 - Fully adjustable, front to rear - RMU markings - Flexible mounting profile along rail - Lacing points	- 3/8" sq. or #10-32 - Fully adjustable, front to rear - RMU markings - Flexible mounting profile along rail - Lacing points	- 3/8" sq. - Adjustable in 6.35mm increments - RMU markings	- 3/8" sq. - Fully adjustable, front to rear - RMU markings - Flexible mounting profile along rail - Square hole pattern to accept "D" rings	- 3/8" sq. - Fully adjustable, front to rear - RMU markings - Flexible mounting profile along rail - Lacing points	- 3/8" sq. or #10-32 - Fully adjustable, front to rear - RMU markings - Flexible mounting profile along rail - Lacing points (30"W cabinet only)	
Cable Management Options	- Vertical cable troughs and managers - Side car - Top trough and ladder rack brackets - Front-to-rear cable trough - Horizontal/vertical cable bars - Finger rail kits - Horizontal cable organizers, 19"	- Vertical cable troughs and managers - Side car - Top trough and ladder rack brackets - Front-to-rear cable trough - Horizontal/vertical cable bars - Finger rail kits - Horizontal cable organizers, 19"	- Horizontal/vertical cable bars - Finger rail kits - Horizontal cable organizers, 19"	- PDU/cable management rail - Vertical cable trough - Horizontal cable organizers, 19"	- Vertical raceways to second & third bays - Raceway entry from top or bottom of cabinet - ¼ turn "D" rings - Finger rail kits - Horizontal cable organizers, 19"	- Vertical cable troughs and cable bars in rear - Side car - Top trough and ladder rack brackets - Front-to-rear cable trough - Horizontal cable bars - Finger rail kits - Horizontal cable organizers, 19"	- Vertical lacing bar installed in each rear corner is standard - Cable knockouts on top and bottom of cabinet - Finger rail kits - Horizontal cable organizers, 19"	
Airflow Options	- Aisle containment - Exhaust chimney - Air manager - Side air flow baffle kit - Brush grommet kit	- Aisle containment - Exhaust chimney - Air manager - Side airflow baffle kit - Brush grommet kit	- Fan assisted doors - Fan assisted top panels - 19" fan trays	- Top cabinet fan assembly - 19" fan trays	- Mesh front door - Rear door with two, 75 CFM fans	- Exhaust chimney - Side airflow baffle kit - Aisle containment	- Fan assembly and exhaust filter - AC units to accommodate 2500 to 20000 BTU	
Power Options	Two sets of PDU brackets with up to 3 (42"D) or 5 (48"D) mounting positions	Two sets of PDU brackets with up to 3 (42"D) or 5 (48"D) mounting positions	Optional PDU bracket with 1 mounting position	One PDU/ cable management rail with up to 2 mounting positions	19" power strips available	Two sets of PDU brackets with up to 3 (42"D) or 5 (48"D) mounting positions	Vertical lacing bar with keyhole pattern for button mounting PDUs	
Color	Black, Winter White	Black, Winter White	Black, Winter White	Black	Black	Black	Black	
Standards	UL2416, RoHS II	UL2416, RoHS II	UL2416, RoHS II	UL2416, RoHS II	RoHS II	GR-63-CORE, RoHS II	UL508A, NEMA 250 Type 12K, RoHS II	



A NEARLY IMPENETRABLE CABINET WITH INTELLIGENT COMPONENTS

Common cabinet configuration includes:

- Welded frame with two pairs of 19" EIA mounting rails with RMU markings and FMP - 3/8" sq. (M6) rails installed; choose tapped #10-32 at no charge
- Two pairs of PDU brackets to accept vertical cable troughs (VCT), vertical cable bars (VCB), and/or PDUs
- Solid tamper resistant top and bottom panels (internally secured)
- Security bracket kit to conceal handle power node inside of cabinet
- SEAL gland plates for all laser etched cable access points (internally secured)
- Pair of solid tamper resistant side panels (internally secured)
- Adjustable levelers, 2.5"H
- Front and rear secure mesh doors with 3-point latch and SEAL-R1000 handle
- Color: Black, Winter White; Custom colors available
- Standards: UL2416, RoHS II



Part No.	RMU	H"	W"	D"	Usable Depth"	UL Rail Rating lbs.	Max. Static Weight lbs.
GL910ES-3048SEAL	48	91	30	48	46	3300	4000
GL910ES-3042SEAL	48	91	30	42	40	3300	4000
GL910ES-2448SEAL	48	91	24	48	46	3300*	4000
GL910ES-2442SEAL	48	91	24	42	40	3300*	4000
GL840ES-3248SEAL	44	84	32	48	46	3300	4000
GL840ES-3242SEAL	44	84	32	42	40	3300	4000
GL840ES-3240SEAL	44	84	32	40	38	3300*	4000
GL840ES-3048SEAL	44	84	30	48	46	3300	4000
GL840ES-3042SEAL	44	84	30	42	40	3300	4000
GL840ES-2448SEAL	44	84	24	48	46	3300*	4000
GL840ES-2442SEAL	44	84	24	42	40	3300*	4000
GL790ES-3048SEAL	42	79	30	48	46	3300	4000
GL790ES-3042SEAL	42	79	30	42	40	3300	4000
GL790ES-2448SEAL	42	79	24	48	46	3300*	4000
GL790ES-2442SEAL	42	79	24	42	40	3300*	4000
GL480ES-2442SEAL	24	48	24	42	40	3300*	4000

*HD Kit must be installed for rail rating of 3300 lbs. (without kit, rail rating is 2000 lbs.); kit can only be factory installed and must be specified at time of order

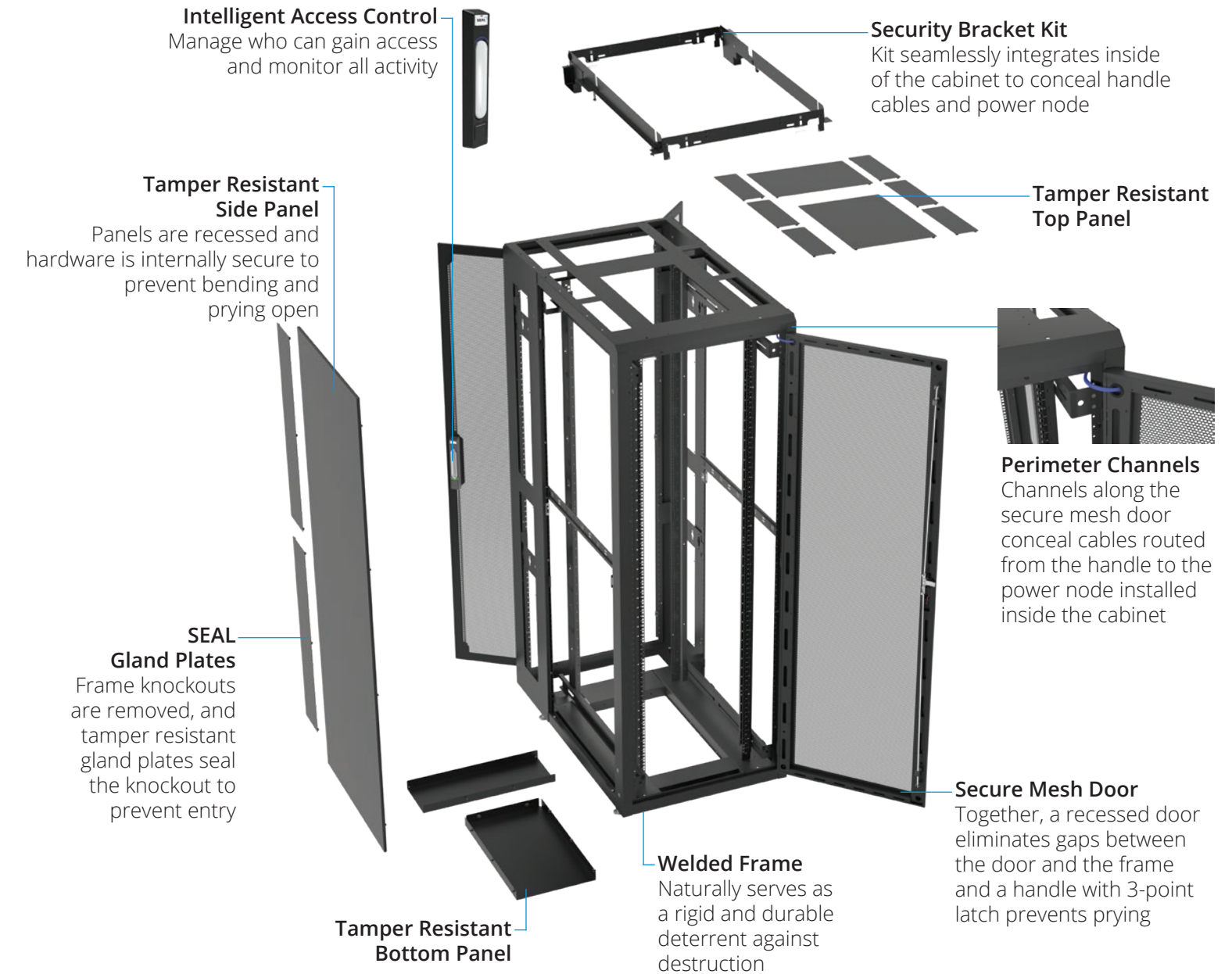

84"H x 30"W x 42"D frame shown, six top cabinet knockouts are part of 30/32" frames only

SECURE HARDWARE COMBINED WITH INTELLIGENT COMPONENTS

ES CABINETS

MOST CONFIGURABLE CABINET FOR EVOLVING DATA CENTER NEEDS

Common cabinet configuration, 'MS' includes:

- Welded frame with two pairs of 19" EIA mounting rails with RMU markings and FMP - 3/8" sq. (M6) rails installed; choose tapped #10-32 at no charge
- Two pairs of PDU brackets to accept vertical cable troughs (VCT), vertical cable bars (VCB), and/or PDUs
- Solid top panel
- Pair of locking, solid lift-off side panels
- Front and rear mesh contour doors with locking swing handles
- Adjustable levelers, 2.5"H
- Color: Black, Winter White; Custom colors available
- Standards: UL2416, RoHS II



SEAL Security Ready. Add intelligent access control to create a SEAL® solution! See page 23

Part No.	RMU	H"	W"	D"	Usable Depth"	UL Rail Rating lbs.	Max. Static Weight lbs.
GL910ES-3048MS	48	91	30	48	46	3300	4000
GL910ES-3042MS	48	91	30	42	40	3300	4000
GL910ES-2448MS	48	91	24	48	46	3300*	4000
GL910ES-2442MS	48	91	24	42	40	3300*	4000
GL840ES-3248MS	44	84	32	48	46	3300	4000
GL840ES-3242MS	44	84	32	42	40	3300	4000
GL840ES-3240MS	44	84	32	40	38	3300*	4000
GL840ES-3048MS	44	84	30	48	46	3300	4000
GL840ES-3042MS	44	84	30	42	40	3300	4000
GL840ES-2448MS	44	84	24	48	46	3300*	4000
GL840ES-2442MS	44	84	24	42	40	3300*	4000
GL790ES-3048MS	42	79	30	48	46	3300	4000
GL790ES-3042MS	42	79	30	42	40	3300	4000
GL790ES-2448MS	42	79	24	48	46	3300*	4000
GL790ES-2442MS	42	79	24	42	40	3300*	4000
GL480ES-2442MS	24	48	24	42	40	3300*	4000

Additional Configuration: 'MSS' includes front mesh contour door and rear split mesh door

*HD Kit must be installed for rail rating of 3300 lbs. (without kit, rail rating is 2000 lbs.); kit can only be factory installed and must be specified at time of order

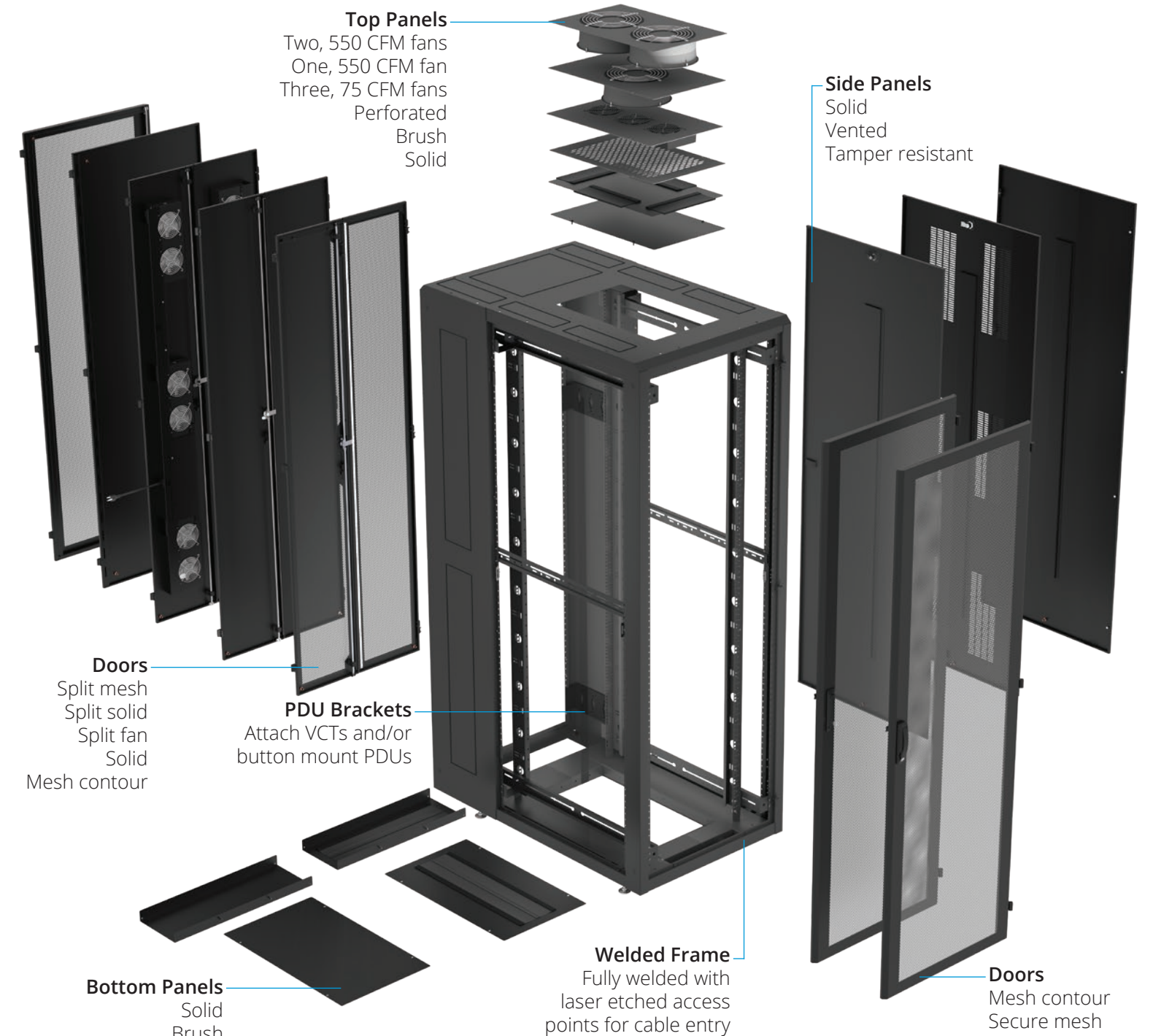

84"H x 30"W x 42"D frame shown, six top cabinet knockouts are part of 30/32" frames only

CHOOSE A STANDARD CONFIGURATION OR MAKE IT YOUR OWN

ES: BUILD YOUR OWN

1. CHOOSE A FRAME

Part No.	RMU	H"	W"	D"	Part No.	RMU	H"	W"	D"	Part No.	RMU	H"	W"	D"
91"H ES FRAMES Frame with two pairs of 3/8" sq. (M6), 19" EIA rails with RMU markings and FMP; two pairs of PDU brackets					84"H ES FRAMES Frame with two pairs of 3/8" sq. (M6), 19" EIA rails with RMU markings and FMP; two pairs of PDU brackets					79"H ES FRAMES Frame with two pairs of 3/8" sq. (M6), 19" EIA rails with RMU markings and FMP; two pairs of PDU brackets				
9101ES-3048	48	91	30	48	8401ES-3248	44	84	32	48	7901ES-3048	42	79	30	48
9101ES-3042	48	91	30	42	8401ES-3242	44	84	32	42	7901ES-3042	42	79	30	42
9101ES-2448	48	91	24	48	8401ES-3048	44	84	30	48	7901ES-2448	42	79	24	48
9101ES-2442	48	91	24	42	8401ES-3042	44	84	30	42	7901ES-2442	42	79	24	42
					8401ES-2448	44	84	24	48					
					8401ES-2442	44	84	24	42					

2. CHOOSE DOORS

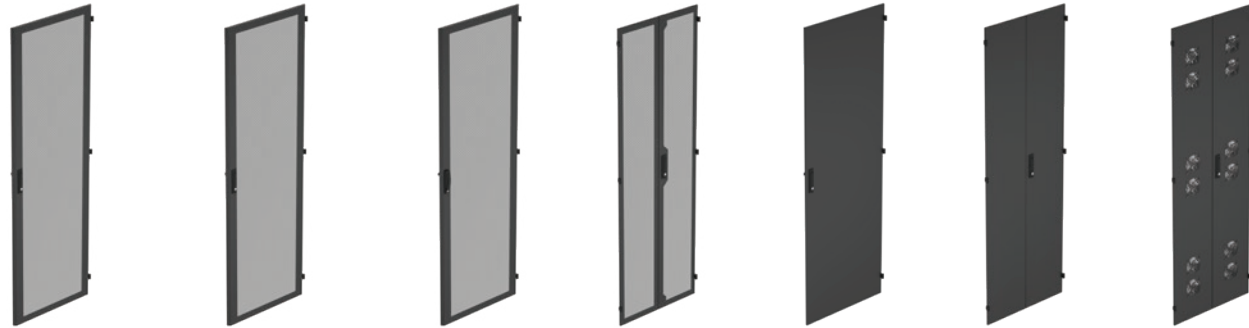

Frame Size	Secure Mesh w/ 3-pt Latch	Hex Mesh w/ 3-pt Latch	Mesh Contour	Split Mesh	Solid	Split Solid	Split Fan
91"H DOORS							
91"H x 30"W	9102E-MC29SLF, front 9102E-MC29SLR, rear	9102E-MCH29SLF, front 9102E-MCH29SLR, rear	9102E-MC29	9102E-29SM	9103E-29	9103E-SS29	9103E-SF29
91"H x 24"W	9102E-MC24SL	9102E-MCH24SL	9102E-MC24	9102E-24SM	9103E-24	9103E-SS24	9103E-SF24
84"H DOORS							
84"H x 30/32"W	8402E-MC29SLF, front 8402E-MC29SLR, rear	8402E-MCH29SLF, front 8402E-MCH29SLR, rear	8402E-MC29	8402E-29SM	8403E-29	8403E-SS29	8403E-SF29
84"H x 24"W	8402E-MC24SL	8402E-MCH24SL	8402E-MC24	8402E-24SM	8403E-24	8403E-SS24	8403E-SF24
79"H DOORS							
79"H x 30"W	7902E-MC29SLF, front 7902E-MC29SLR, rear	7902E-MCH29SLF, front 7902E-MCH29SLR, rear	7902E-MC29	7902E-29SM	7903E-29	7903E-SS29	7903E-SF29
79"H x 24"W	7902E-MC24SL	7902E-MCH24SL	7902E-MC24	7902E-24SM	7903E-24	7903E-SS24	7903E-SF24

3. CHOOSE SIDES

Part No.	Compatible ES	Part No.	Compatible ES	Part No.	Compatible ES				
SOLID SIDES Pair of locking, lift-off sides									
9110-36ELS	91"H ES sizes	VENTED SIDES Pair of locking, lift-off sides							
8410-36ELS	84"H ES sizes	9111-36ELL	91"H ES sizes	TAMPER RESISTANT SIDES Pair of solid sides, internally secure					
7910-36ELS	79"H ES sizes	8411-36ELL	84"H ES sizes	9110-36EIS	91"H ES sizes				
		7911-36ELL	79"H ES sizes	8410-36EIS	84"H ES sizes				
				7910-36EIS	79"H ES sizes				

4. CHOOSE A TOP

TPES-S TPES-SCC	Solid top Solid top, tamper resistant	TPES-B	Brush top	TPES-P TPES-PCC	Perforated top Perforated top, tamper resistant
TPES-F	Three, 75 CFM fans, 115V top	TPES-F10	One, 550 CFM fan, 115V top	TPES-F10	Two, 550 CFM fans, 115V top

5. CHOOSE A BOTTOM

Solid bottom		30/32"W SOLID BOTTOM		24"W SOLID BOTTOM	
Brush bottom		BPSES3048	30/32"W x 48"D ES sizes	BPSES2448	24"W x 48"D ES sizes
		BPSES3042	30/32"W x 42"D ES sizes	BPSES2442	24"W x 42"D ES sizes
		30/32"W BRUSH BOTTOM		24"W BRUSH BOTTOM	
		BPBES3048	30/32"W x 48"D ES sizes	BPBES2448	24"W x 48"D ES sizes
		BPBES3042	30/32"W x 42"D ES sizes	BPBES2442	24"W x 42"D ES sizes

6. CABINET ACCESSORIES AND EXTRAS

For casters, levelers, and other options, see page 57-58.

ES EXTERNAL CABLE MANAGEMENT

Top Cable Trough
No ladder rack or overhead building changes needed—support cables with a single product

Ladder Rack Bracket
Height adjustable LRB; use on cabinets of various heights

Side Car Side Panel
Add an optional panel when side car is used at the end of a row

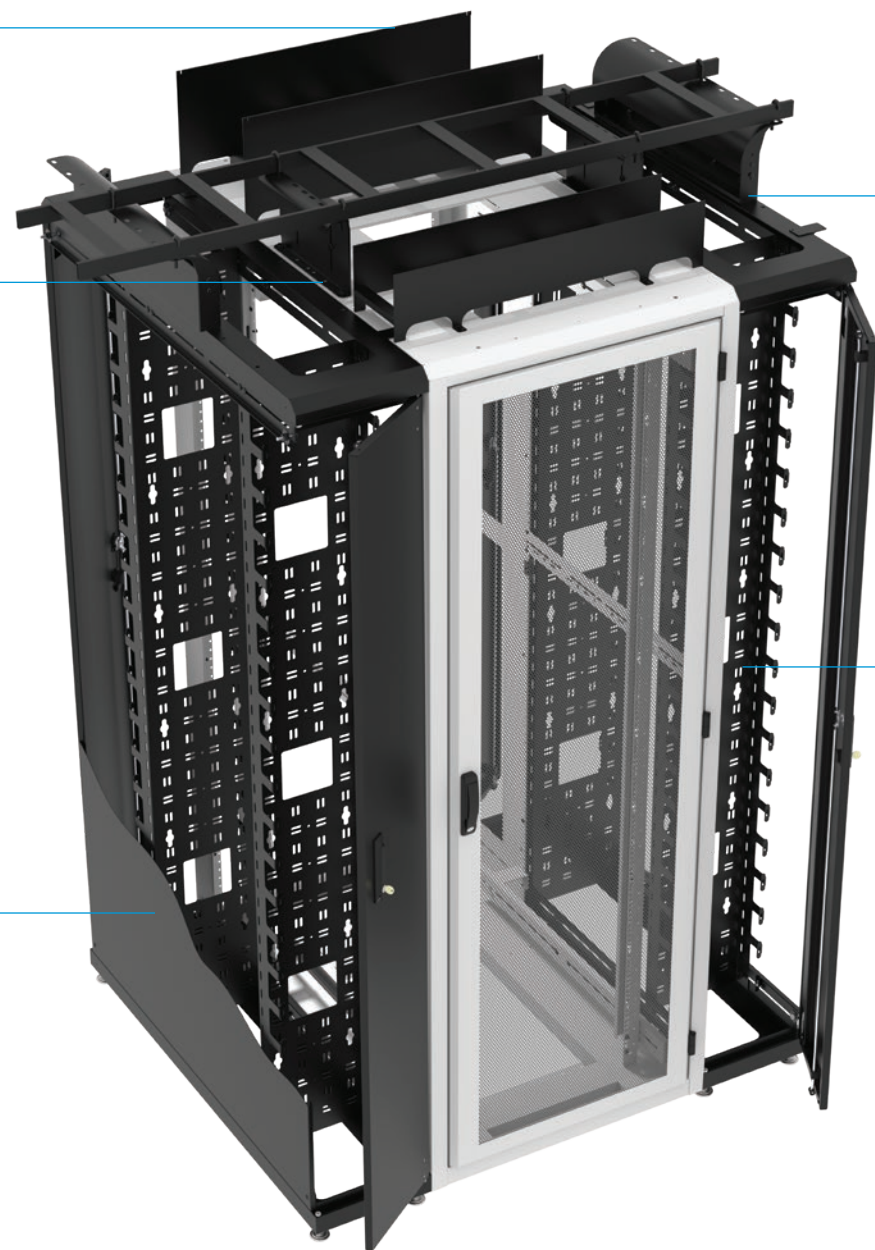

Waterfall Ladder Rack Bracket
3" bend radius helps maintain proper cable standards

Side Car
Improve airflow in the cabinet and create better network installations by moving cable bundles to the side car — a dedicated space for cable management and power

84"H x 30"W x 42"D frame shown, six top cabinet knockouts are part of 30/32" frames only

FULLY SUPPORT OVERHEAD CABLES WITH AS LITTLE AS ONE PART

Part No.	Description	Compatible ES
----------	-------------	---------------

SIDE CAR

Horizontally adjustable troughs with obround pattern for cinch straps and keyhole pattern for button mounting PDUs; dual hinge front and rear door; optional cover panel available when used at end of row

SC129148	91"H X 12"W X 48"D SC	91"H x 48"D ES
SC69148	91"H X 6"W X 48"D SC	91"H x 48"D ES
SCP9148	Cover for 91"H x 48"D SC	91"H x 48"D ES
SC129142	91"H X 12"W X 42"D SC	91"H x 42"D ES
SC69142	91"H X 6"W X 42"D SC	91"H x 42"D ES
SCP9142	Cover for 91"H x 42"D SC	91"H x 42"D ES
SC128448	84"H X 12"W X 48"D SC	84"H x 48"D ES
SC68448	84"H X 6"W X 48"D SC	84"H x 48"D ES
SCP8448	Cover for 84"H x 48"D SC	84"H x 48"D ES
SC128442	84"H X 12"W X 42"D SC	84"H x 42"D ES
SC68442	84"H X 6"W X 42"D SC	84"H x 42"D ES
SCP8442	Cover for 84"H x 42"D SC	84"H x 42"D ES
SC127948	79"H X 12"W X 48"D SC	79"H x 48"D ES
SC67948	79"H X 6"W X 48"D SC	79"H x 48"D ES
SCP7948	Cover for 79"H x 48"D SC	79"H x 48"D ES
SC127942	79"H X 12"W X 42"D SC	79"H x 42"D ES
SC67942	79"H X 6"W X 42"D SC	79"H x 42"D ES
SCP7942	Cover for 79"H x 42"D SC	79"H x 42"D ES

Part No.	Description	Compatible ES
----------	-------------	---------------

WATERFALL LADDER RACK BRACKET

Part number includes single bracket; load rating 100 lbs.

4PLRBV4-8	Configure LRB to 4, 6, and 8" height; supports 12-24"W ladder	All ES sizes
-----------	---	--------------

Part No.	Description	Compatible ES
----------	-------------	---------------

LADDER RACK BRACKET, FIXED HEIGHT

Part number includes single bracket with integrated radius; use on cabinets of same height when in a row; load rating of 100 lbs.

LRB-12	3" LRB supports 12"W ladder rack	All ES sizes
LRB-24	3" LRB supports 12-24"W ladder	All ES sizes

Part No.	Description	Compatible ES
----------	-------------	---------------

LADDER RACK BRACKET, ADJUSTABLE HEIGHT

Part number includes single bracket with integrated radius; use on cabinets of various heights when in a row; load rating of 100 lbs.

LRB-12A1	6-11.5" LRB supports 12"W ladder	All ES sizes
LRB-12A2	14-24" LRB supports 12"W ladder	All ES sizes
LRB-24A1	6-11.5" LRB supports 12-24"W ladder	All ES sizes
LRB-24A2	14-24" LRB supports 12-24"W ladder	All ES sizes

Part No.	Description	Compatible ES
----------	-------------	---------------

TOP CABLE TROUGH

Trough installs directly on cabinet top and requires no additional brackets or hardware (when compared to ladder rack) to support cable bundles

TCT32HD	12"W x 6"D x 32"L trough	32"W ES
TCT30HD	12"W x 6"D x 30"L trough	30"W ES
TCT24HD	12"W x 6"D x 24"L trough	24"W ES
TCT1206EC	End cap assembly	Use with TCTHD
TCT32	6.5"W x 4"D x 32"L trough	32"W ES
TCT30	6.5"W x 4"D x 30"L trough	30"W ES
TCT30EC	End cap assembly	Use with TCT30, TCT32
TCT24	6.5"W x 4"D x 24"L trough	24"W ES
TCT24EC	End cap assembly	Use with TCT24

ES INTERNAL CABLE MANAGEMENT

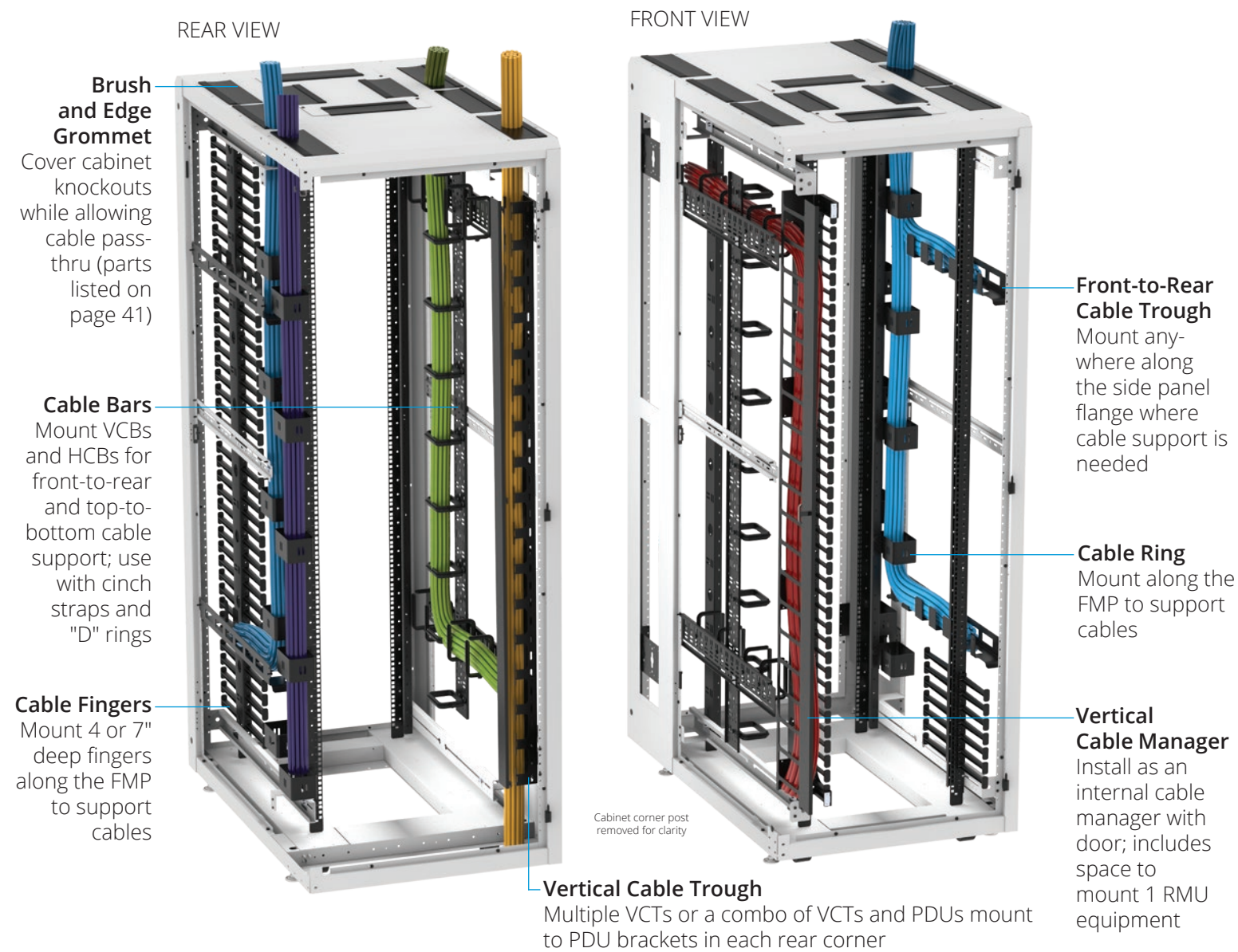

Part No.	Description	Compatible ES
----------	-------------	---------------

CABLE BARS

Kits include one vertical cable bar (VCB), two horizontal cable bars (HCB), and six 12"L cinch straps; single VCBs must be used with a kit; all bars feature square hole pattern to use with optional ¼ turn "D" rings and obround pattern for cinch straps

VCB-9136	75"H x 4"W VCB Kit	91"H ES sizes
VCB-8436	68"H x 4"W VCB Kit	84"H ES sizes
VCB-7936	62"H x 4"W VCB Kit	79"H ES sizes
VCB-91	75"H x 4"W single VCB	91"H ES sizes
VCB-84	68"H x 4"W single VCB	84"H ES sizes
VCB-79	62"H x 4"W single VCB	79"H ES sizes
HCB-36	29.5"H x 4"W single HCB	All ES sizes
CM-25	¼ turn "D" rings 1.5" x 3.5", set of 10	All ES sizes
CM-26	¼ turn "D" rings 3.5" x 5", set of 10	All ES sizes

Part No.	Description	Compatible ES
----------	-------------	---------------

VERTICAL CABLE MANAGER

Manager with fingers and hinged cover (magnetic close) installs alongside the rail; includes space to vertically mount three, 1 RMU pieces of equipment

VCM-91K	75.25"H x 3.78"W x 7.5"D VCM	30/32"W ES sizes
VCM-84K	70"H x 3.78"W x 7.5"D VCM	30/32"W ES sizes
VCM-79K	63"H x 3.78"W x 7.5"D VCM	30/32"W ES sizes

Part No.	Description	Compatible ES
----------	-------------	---------------

VERTICAL CABLE TROUGH

Install in any rear corner of the ES; mounts to standard universal PDU brackets

VCT-91	76"H x 3"W x 2.5"D VCT	91"H ES sizes
VCT-91C	Cover for VCT-91	91"H ES sizes
VCT-84	68"H x 3"W x 2.5"D VCT	84"H ES sizes
VCT-84C	Cover for VCT-84	84"H ES sizes
VCT-79	62"H x 3"W x 2.5"D VCT	79"H ES sizes
VCT-79C	Cover for VCT-79	79"H ES sizes

Part No.	Description	Compatible ES
----------	-------------	---------------

FRONT-TO-REAR CABLE TROUGH

Mounts to side panel flange; independent of EIA rail depth

HCM-D36	2.5"H x 2.6"W x 29"L trough	30/32"W ES sizes
---------	-----------------------------	------------------

Part No.	Description	Compatible ES
----------	-------------	---------------

FINGERS & RINGS

Accessories mount along the FMP of ES rails; when fingers are used on front rails, rails must be recessed

CM-47	4" X 7 RMU, single finger section	All ES sizes
ESC-K12	4" x 7 RMU, set of 12 finger sections	All ES sizes
CM-77	7" X 7 RMU, single finger section	All ES sizes
ESC-K12-7	7" x 7 RMU, set of 12 finger sections	All ES sizes
CM-11	3"W x 5"D, set of five rings to mount along the FMP of ES rails	30/32"W ES sizes

Part No.	Description	Compatible ES
----------	-------------	---------------

ZERO-U MOUNTING BRACKETS

Set of two brackets mount along the FMP of ES rails to vertically mount 19" equipment such as patch panels and horizontal cable organizers

ZR2	Mounts 2 RMU of equipment	30/32"W ES sizes
ZR1	Mounts 1 RMU of equipment	30/32"W ES sizes

Part No.	Description	Compatible ES
----------	-------------	---------------

CINCH STRAPS

Use with mounting rails and accessories that feature an obround pattern

CM-01	3/4"W x 12"L, single blue strap	All ES sizes
CM-06	3/4"W x 6"L, single black strap	All ES sizes

For 19" cable organizers and other rack mount accessories, see page 135

84"H x 30"W x 42"D frame shown, six top cabinet knockouts are part of 30/32" frames only, not all accessories shown are compatible with smaller cabinets

INTERNAL OPTIONS THAT PROVIDE MAXIMUM FLEXIBILITY

ES AIRFLOW

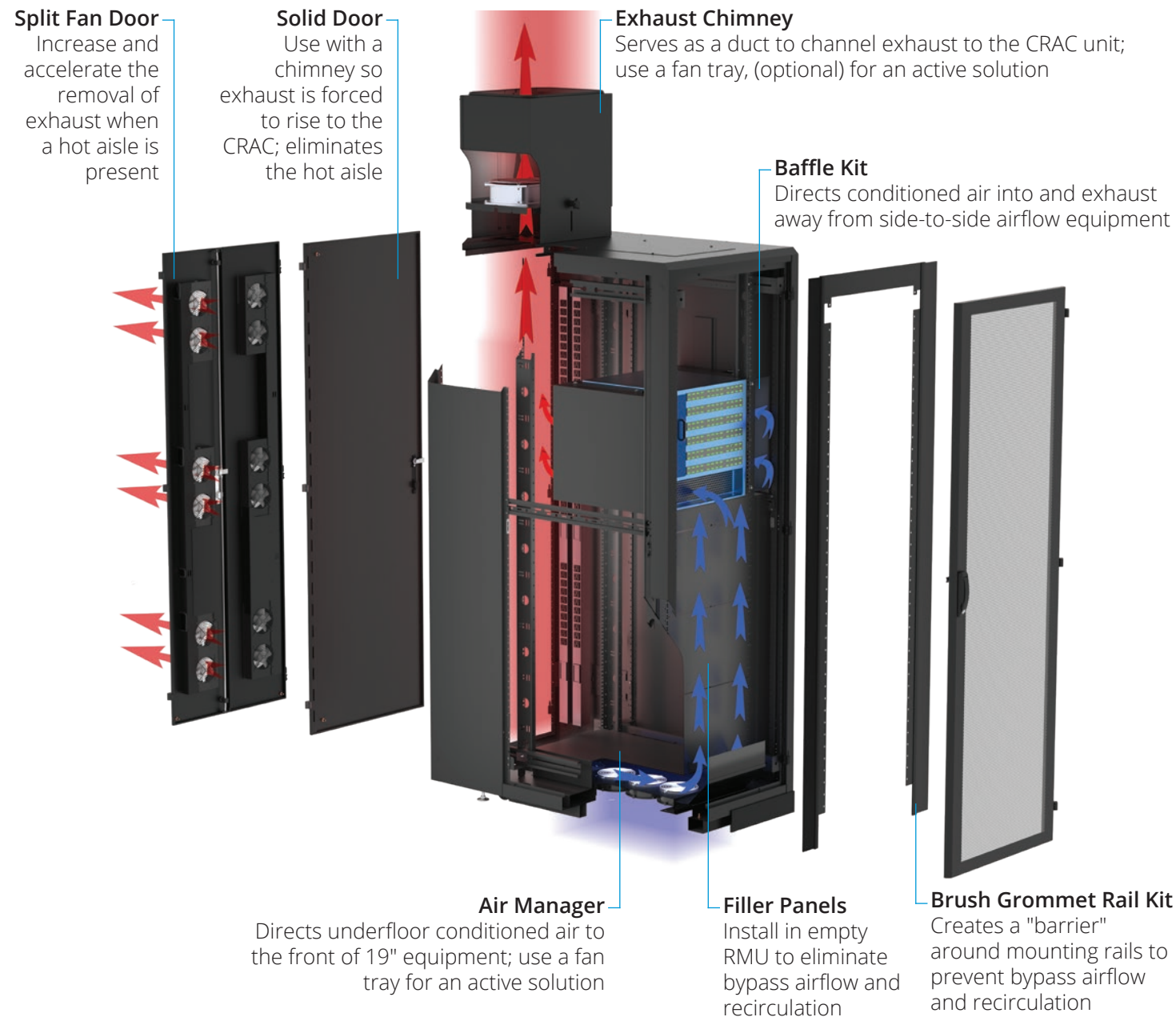

84"H x 30"W x 42"D frame shown; *Fan door should not be used in conjunction with an exhaust chimney

SEGREGATE AIRFLOW IN THE CABINET FOR A LOCALIZED CONTAINMENT SOLUTION

Part No.	Description	Compatible ES
----------	-------------	---------------

BRUSH GROMMET RAIL KIT

Rail-height metal strip and brush grommet installs along FMP; extends from the rail to side panel to prevent air recirculation while allowing cable pass-thru

BGRK-91-30	Brush grommet rail kit	91"H x 30"W ES sizes
BGRK-91-24	Brush grommet rail kit	91"H x 24"W ES sizes
BGRK-84-32	Brush grommet rail kit	84"H x 32"W ES sizes
BGRK-84-30	Brush grommet rail kit	84"H x 30"W ES sizes
BGRK-84-24	Brush grommet rail kit	84"H x 24"W ES sizes
BGRK-79-30	Brush grommet rail kit	79"H x 30"W ES sizes
BGRK-79-24	Brush grommet rail kit	79"H x 24"W ES sizes

Part No.	Description	Compatible ES
----------	-------------	---------------

BRUSH GROMMET FOR CABLE PASS THRU

Line cabinet knockouts with edge grommet; cover with brush to prevent air recirculation

BGT	Six top cabinet knockouts	30/32"W ES sizes
TP48ESBB	Top chimney knockout	48"D ES sizes
TP42ESBB	Top chimney knockout	42"D ES sizes
BGS-91-48	Two side cabinet knockouts	91"H x 48"D ES sizes
BGS-91	Two side cabinet knockouts	91"H x 42"D ES sizes
BGS-84-48	Two side cabinet knockouts	84"H x 48"D ES sizes
BGS-84	Two side cabinet knockouts	84"H x 42"D ES sizes
BGS-79-48	Two side cabinet knockouts	79"H x 48"D ES sizes
BGS-79	Two side cabinet knockouts	79"H x 42"D ES sizes

Part No.	Description	Compatible ES
----------	-------------	---------------

BAFFLE KITS

Baffle attaches to FMP to direct airflow of side-to-side airflow equipment

ESSAB19	15.8" to 18.5"D, 19 RMU switch	30/32"W ES sizes
ESSAB14	15.8" to 18.1"D, 14 RMU switch	30/32"W ES sizes
ESSAB14D	25.7" to 28"D, 14 RMU switch	30/32"W ES sizes
ESSAB11	15.8" to 18.1"D, 11 RMU switch	30/32"W ES sizes

Part No.	Description	Compatible ES
----------	-------------	---------------

EXHAUST CHIMNEY

Adjustable height chimney serves as a duct that channels exhaust to the plenum/CRAC unit

GL-ECHF-48-1832	High flow chimney, 18-32"	48"D ES sizes
GL-ECHF-48-3246	High flow chimney, 32-46"	48"D ES sizes
GL-ECHFFT48	High flow fan tray, 2260 CFM	48"D ES sizes
GL-EC-48-1832	Chimney, 18-32"	48"D ES sizes
GL-EC-48-3246	Chimney, 32-46"	48"D ES sizes
GL-ECFT48	Fan tray, 1200 CFM	48"D ES sizes
GL-EC-42-1832	Chimney, 18-32"	42"D ES sizes
GL-EC-42-3246	Chimney, 32-46"	42"D ES sizes
GL-ECFT42	Fan tray, 1200 CFM	42"D ES sizes

Part No.	Description	Compatible ES
----------	-------------	---------------

AIR MANAGER

Adjustable air manager mounts in the bottom of the cabinet and directs underfloor conditioned air to the front of rack mount equipment

AM-HFES	High flow air manager, 2 RMU	All ES sizes
AM-HFFTES30	High flow fan tray, 940 CFM	30/32"W ES sizes
AM-HFFTES24	High flow fan tray, 940 CFM	24"W ES sizes
AM-ES	Air manager, 1 RMU	All ES sizes
AM-FTES30	Fan tray, 600 CFM	30/32"W ES sizes
AM-FTES24	Fan tray, 600 CFM	24"W ES sizes

Part No.	Description	Compatible ES
----------	-------------	---------------

UNDER RACK PANELS & FOAMBLOCK

Prevent conditioned air from flowing around cabinet casters/levelers

GLAL10126CP	Under rack panel, 27.5" x 4.53" x 1", attaches magnetically, pack of 10	All ES sizes
GLAL10127CP	Under rack panel, 31.5" x 4.53" x 1", attaches magnetically, pack of 10	30/32"W ES sizes
FOAMBLOCK	24" x 24" high density foam, perforated 1" x 1", pack of six sheets	All ES sizes

For 19" cable organizers, filler panels and other rack mount accessories, see page 135

E CABINETS

EXTENSIVE LINE OF CABINETS FOR USE IN SMALL-TO-LARGE DEPLOYMENTS

Common cabinet configuration 'MS' includes:

- Welded frame with two pairs of 19" EIA mounting rails with RMU markings and FMP - 3/8" sq. (M6) rails installed; choose tapped #10-32 at no charge
- Solid top panel with horseshoe knockouts
- Pair of locking, solid lift-off side panels
- Front and rear mesh doors with locking swing handles
- Adjustable levelers, 2.5"H
- Color: Black, Winter White; Custom colors available
- Standards: UL2416, RoHS II



Part No.	RMU	H"	W"	D"	Usable Depth"	UL Rail Rating lbs.	Max. Static Weight lbs.
GL840E-2936MS	44	84	29	36	34	1500	2500
GL840E-2932MS	44	84	29	32	30	1500	2500
GL840E-2436MS	44	84	24	36	34	1500	2500
GL840E-2432MS	44	84	24	32	30	1500	2500
GL720E-2936MS	37	72	29	36	34	1500	2500
GL720E-2932MS	37	72	29	32	30	1500	2500
GL720E-2436MS	37	72	24	36	34	1500	2500
GL720E-2432MS	37	72	24	32	30	1500	2500
GL600E-2432MS	31	60	24	32	30	600	600
GL480E-2432MS	24	48	24	32	30	600	600
GL300E-2432MS	13	30	24	32	30	600	600

Additional Configuration: 'P' includes front plexi and rear perimeter vented steel doors with perforated top panel

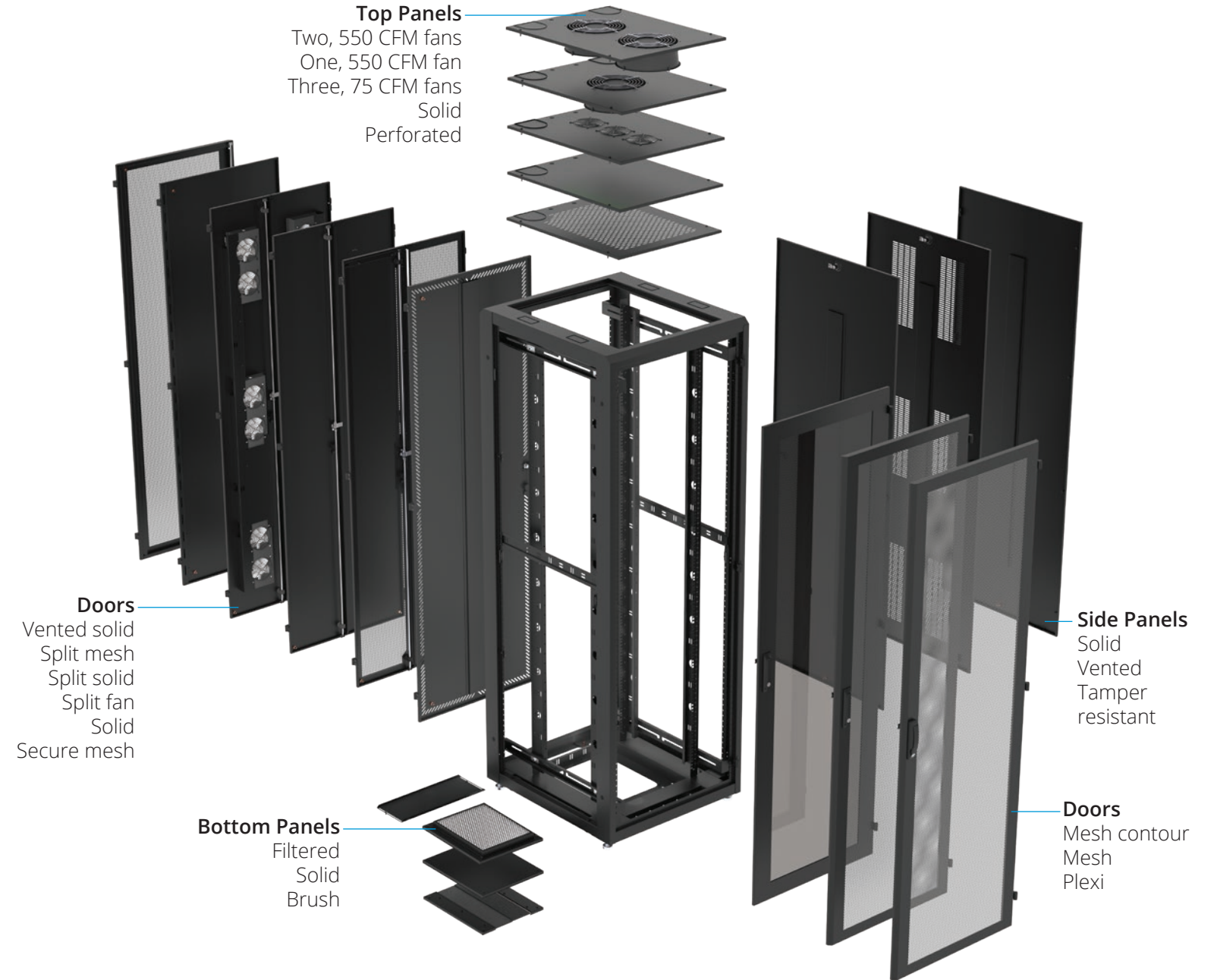

84"H x 29"W x 32"D frame shown, four top cabinet knockouts are part of 29" frames only, not all accessories shown are compatible with smaller cabinets

SIZE AND OPTIONS FOR SMALL OFFICE TO DATA CENTER ENVIRONMENTS

E: BUILD YOUR OWN

1. CHOOSE A FRAME

Part No.	RMU	H"	W"	D"	Part No.	RMU	H"	W"	D"	Part No.	RMU	H"	W"	D"
84"H E FRAMES Frame with two pairs of 3/8" sq. (M6), 19" EIA mounting rails with RMU markings and FMP					72"H E FRAMES Frame with two pairs of 3/8" sq. (M6), 19" EIA mounting rails with RMU markings and FMP					60"H & SMALLER E FRAMES Frame with two pairs of 3/8" sq. (M6), 19" EIA mounting rails with RMU markings and FMP				
8401E-2936	44	84	29	36	7201E-2936	37	72	29	36	6001E-2432	31	60	24	32
8401E-2932	44	84	29	32	7201E-2932	37	72	29	32	4801E-2432	24	48	24	32
8401E-2436	44	84	24	36	7201E-2436	37	72	24	36	3001E-2432	13	30	24	32
8401E-2432	44	84	24	32	7201E-2432	37	72	24	32					

2. CHOOSE DOORS

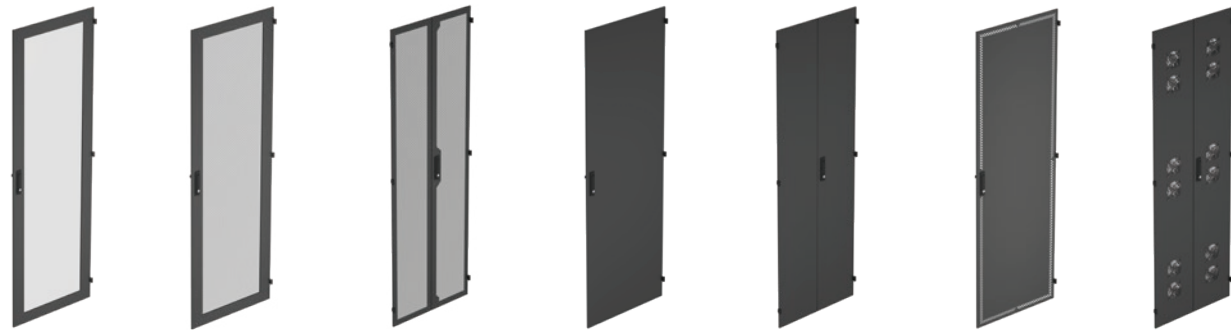

Frame Size	Plexi	Mesh	Split Mesh	Solid	Split Solid	Perimeter Vented Solid	Split Fan
84"H DOORS							
84"H x 29"W	8402E-29	8402E-M29	8402E-29SM	8403E-29	8403E-SS29	8404E-29	8403E-SF29
84"H x 24"W	8402E-24	8402E-M24	8402E-24SM	8403E-24	8403E-SS24	8404E-24	8403E-SF24
72"H DOORS							
72"H x 29"W	7202E-29	7202E-M29	7202E-29SM	7203E-29	N/A	7204E-29	N/A
72"H x 24"W	7202E-24	7202E-M24	7202E-24SM	7203E-24	N/A	7204E-24	N/A
60"H & SMALLER DOORS							
60"H x 24"W	6002E-24	6002E-M24	N/A	6002E-24SM	N/A	6004E-24	N/A
48"H x 24"W	4802E-24	4802E-M24	N/A	4802E-24SM	N/A	4804E-24	N/A
30"H x 24"W	3002E-24	3002E-M24	N/A	3002E-24SM	N/A	3004E-24	N/A

3. CHOOSE SIDES

Part No.	Compatible E	Part No.	Compatible E	Part No.	Compatible E
84" & 72"H SOLID SIDES Pair of locking, lift-off sides		84" & 72"H VENTED SIDES Pair of locking, lift-off sides		60" & SMALLER SIDES Pair of locking, lift-off sides	
8410-36ELS	84"H x 36"D E sizes	8411-36ELL	84"H x 36"D E sizes	6010-32ELS	60"H x 32"D E sizes, solid
8410-32ELS	84"H x 32"D E sizes	8411-32ELL	84"H x 32"D E sizes	4810-32ELS	48"H x 32"D E sizes, solid
7210-36ELS	72"H x 36"D E sizes	7211-36ELL	72"H x 36"D E sizes	3010-36ELS	30"H x 32"D E sizes, solid
7210-32ELS	72"H x 32"D E sizes	7211-32ELL	72"H x 32"D E sizes	6011-32ELL	60"H x 32"D E sizes, vented
				4811-32ELL	48"H x 32"D E sizes, vented
				3011-36ELL	30"H x 32"D E sizes, vented

4. CHOOSE A TOP

Solid Top TPE-29S 29"W TPE-24S 24"W	Perforated Top TPE-29P 29"W TPE-24P 24"W
Fan Top; one, 550 CFM fan, 115V TPE-29F10 29"W TPE-24F10 24"W	Fan Top; two, 550 CFM fans, 115V TPE-292F10 29"W TPE-242F10 24"W
	Fan Top; three, 75 CFM fans, 115V TPE-29F 29"W TPE-24F 24"W

5. CHOOSE A BOTTOM

Part No.	Compatible E	Part No.	Compatible E	Part No.	Compatible E
BRUSH BOTTOM		SOLID BOTTOM		FILTERED BOTTOM	
BPB29	84/72"H x 29"W E sizes	BPS29	84/72"H x 29"W E sizes	BPF29	84/72"H x 29"W E sizes
BPB24	84/72"H x 24"W E sizes	BPS24	84/72"H x 24"W E sizes	BPF24	84/72"H x 24"W E sizes
BP-EB	60" and smaller E sizes	BP-ES	60" and smaller E sizes	BP-EF	60" and smaller E sizes

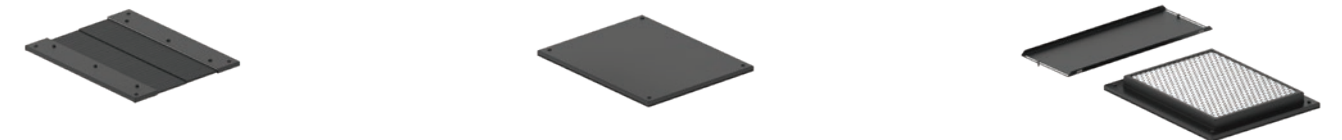

6. CABINET ACCESSORIES AND EXTRAS

For casters, levelers, and other options, see page 57-58.

E CABLE MANAGEMENT & AIRFLOW

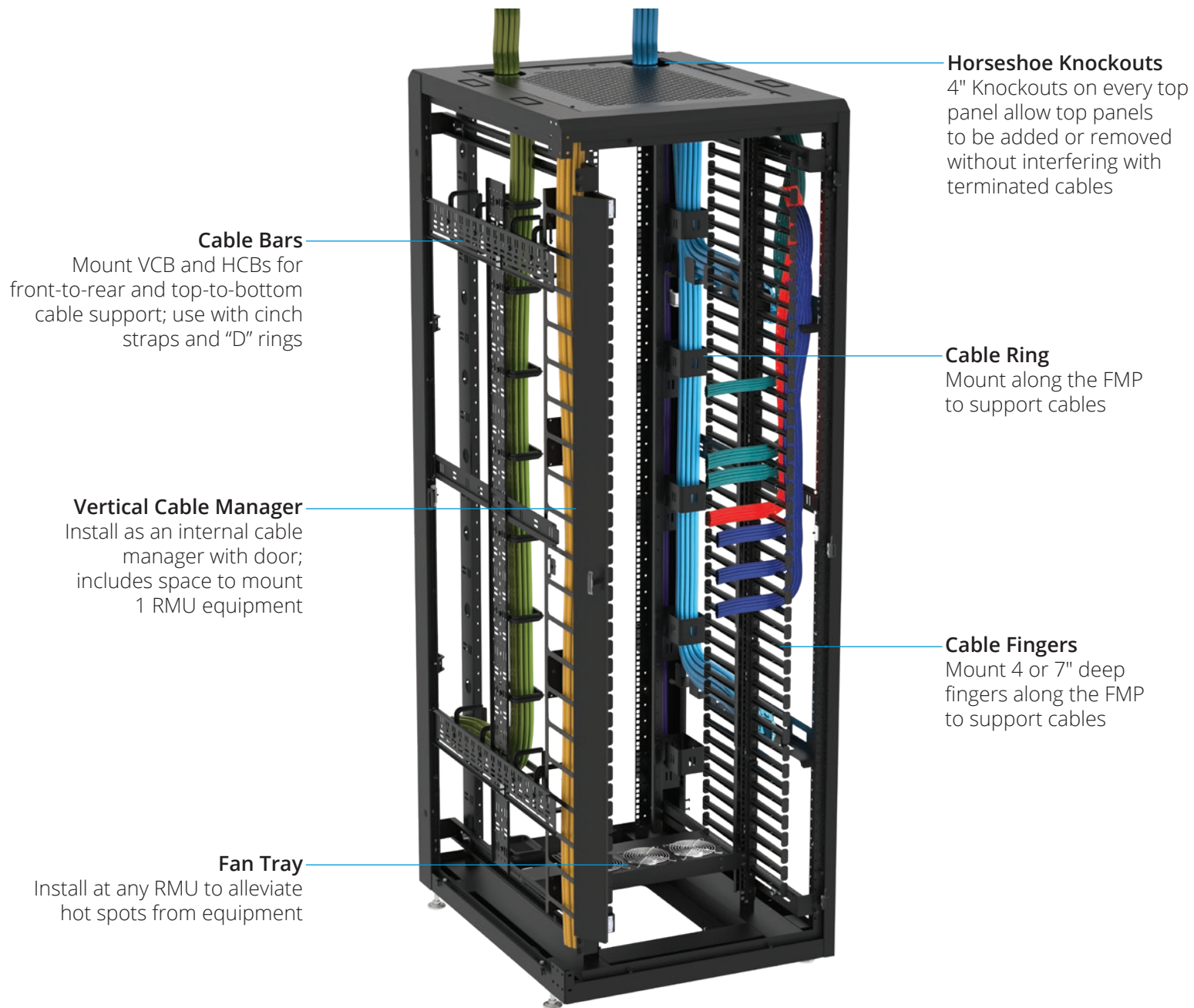

Cable Bars

Mount VCB and HCBs for front-to-rear and top-to-bottom cable support; use with cinch straps and "D" rings

Vertical Cable Manager

Install as an internal cable manager with door; includes space to mount 1 RMU equipment

Fan Tray

Install at any RMU to alleviate hot spots from equipment

Horseshoe Knockouts

4" Knockouts on every top panel allow top panels to be added or removed without interfering with terminated cables

Cable Ring

Mount along the FMP to support cables

Cable Fingers

Mount 4 or 7" deep fingers along the FMP to support cables

84"H x 29"W x 32"D frame shown, four top cabinet knockouts are part of 29" frames only, not all accessories shown are compatible with smaller cabinets

SIMPLE CONFIGURABILITY TO MANAGE CABLES & AIRFLOW

Part No.	Description	Compatible E
----------	-------------	--------------

CABLE BARS

Kits include one vertical cable bar (VCB), two horizontal cable bars (HCB), and six 12"L cinch straps; single VCBs must be used with a kit; all bars feature square hole pattern to use with optional ¼ turn "D" rings and obround pattern for cinch straps

VCB-8436	62"H x 4"W VCB Kit	84"H x 36"D E sizes
VCB-8432	62"H x 4"W VCB Kit	84"H x 32"D E sizes
VCB-7236	56"H x 4"W VCB Kit	72"H x 36"D E sizes
VCB-7232	56"H x 4"W VCB Kit	72"H x 32"D E sizes
VCB-4832	32"H x 4"W VCB Kit	48"H x 32"D E sizes
VCB-84	68"H x 4"W single VCB	84"H E sizes
VCB-72	62"H x 4"W single VCB	72"H E sizes
VCB-48	32"H x 4"W single VCB	48"H E sizes
HCB-36	29.5"H x 4"W single HCB	36"D E sizes
HCB-32	25.5"H x 4"W single HCB	32"D E sizes
CM-25	1.5" x 3.5", set of 10 rings	All E sizes
CM-26	3.5" x 5", set of 10 rings	All E sizes

Part No.	Description	Compatible E
----------	-------------	--------------

VERTICAL CABLE MANAGER

Install alongside the E rail to vertically mount three pieces of 1 RMU equipment; mounts to the FMP on the front face of E rails

VCM-84K	70"H x 3.78"W x 7.5"D VCM	84"H x 29"W E sizes
---------	---------------------------	---------------------

Part No.	Description	Compatible E
----------	-------------	--------------

ZERO-U MOUNTING BRACKETS

Set of two brackets mount along the FMP of E rails to vertically mount 19" equipment such as patch panels and horizontal cable organizers

ZR2	Mounts 2 RMU of equipment	29"W E sizes
ZR1	Mounts 1 RMU of equipment	29"W E sizes

Part No.	Description	Compatible E
----------	-------------	--------------

FINGERS & RINGS

Accessories mount along the FMP of E rails; when fingers are used on front rails, rails must be recessed

CM-47	4" X 7 RMU, single finger section	All E sizes
ESC-K12	4" x 7 RMU, set of 12 finger sections	All E sizes
CM-77	7" X 7 RMU, single finger section	All E sizes
ESC-K12-7	7" x 7 RMU, set of 12 finger sections	All E sizes
CM-11	3"W x 5"D, set of five rings to mount along the FMP of E rails	29"W E sizes

Part No.	Description	Compatible E
----------	-------------	--------------

FAN TRAYS FOR 19" MOUNTING

Front/rear mount adjustable or fixed tray, includes three 75 CFM fans; requires 2 RMU

7217FT-3	Adjustable tray, 115V	All E sizes
7217FT-3-230	Adjustable tray, 207-253V	All E sizes
7217FT	Fixed tray, 115V	All E sizes
7217FT-230	Fixed tray, 207-253V	All E sizes
FTBKT90	Bracket to mount 7217FT at 90° angle	All E sizes

Part No.	Description	Compatible E
----------	-------------	--------------

CINCH STRAPS

Use with parts that feature obround pattern (mounting rails, VCBs & HCBs)

CM-01	3/4"W x 12"L, single blue strap	All E sizes
CM-06	3/4"W x 6"L, single black strap	All E sizes

For 19" cable organizers, filler panels and other rack mount accessories, see page 135

L CABINETS

READY-TO-SHIP CABINET FOR SWIFT DEPLOYMENT OF ONE OR HUNDREDS

Common cabinet configuration includes:

- Frame with two pairs of 19" EIA mounting rails with RMU markings
 - Two pairs of 3/8" sq. (M6) rails installed
- Single PDU/cable management rail with keyhole pattern for button mounting PDUs and lacing point pattern for cinch straps
- Solid top panel
- Half-height solid side panels with locks
- Adjustable levelers (2.5"H) and casters installed (*GL910L cabinet is 88"H with levelers/casters, 86"H without; GL790L cabinet is 79"H with levelers/casters installed, 77"H without)
- Front mesh door with locking swing handle
- Rear split mesh door with locking swing handle
- Color: Black
- Standards: UL2416, RoHS II



Part No.	RMU	H"	W"	D"	Usable Depth"	UL Rail Rating lbs.
GL910L-3248MSS	47	91*	32	48	42	3000
GL910L-3242MSS	47	91*	32	40	34	3000
GL910L-2448MSS	47	91*	24	48	42	3000
GL910L-2442MSS	47	91*	24	40	34	3000
GL790L-3248MSS	42	79*	32	48	42	3000
GL790L-3242MSS	42	79*	32	40	34	3000
GL790L-2448MSS	42	79*	24	48	42	3000
GL790L-2442MSS	42	79*	24	40	34	3000

Part No.	Description	Compatible Cabinet
----------	-------------	--------------------

CABLE MANAGEMENT AND FAN KIT

VCB-91L	Vertical PDU/cable management rail for button mounting PDUs and lacing points for cinch straps	91"H L sizes
VCB-79L	Vertical PDU/cable management rail for button mounting PDUs and lacing points for cinch straps	79"H L sizes
VCT-91L	Vertical cable trough includes thirteen 3.25" metal cable loops	91"H L sizes
VCT-79L	Vertical cable trough includes thirteen 3.25" metal cable loops	79"H L sizes
7217L	Fan assembly with two 75 CFM fans; remove gland plate on cabinet for installation	All L sizes

For cabinet extras (hardware, bus bars, etc.), see page 57; for 19" cable organizers, filler panels and other rack mount accessories, see page 135

Top Gland Plate
Use for cable access or install optional fan assembly

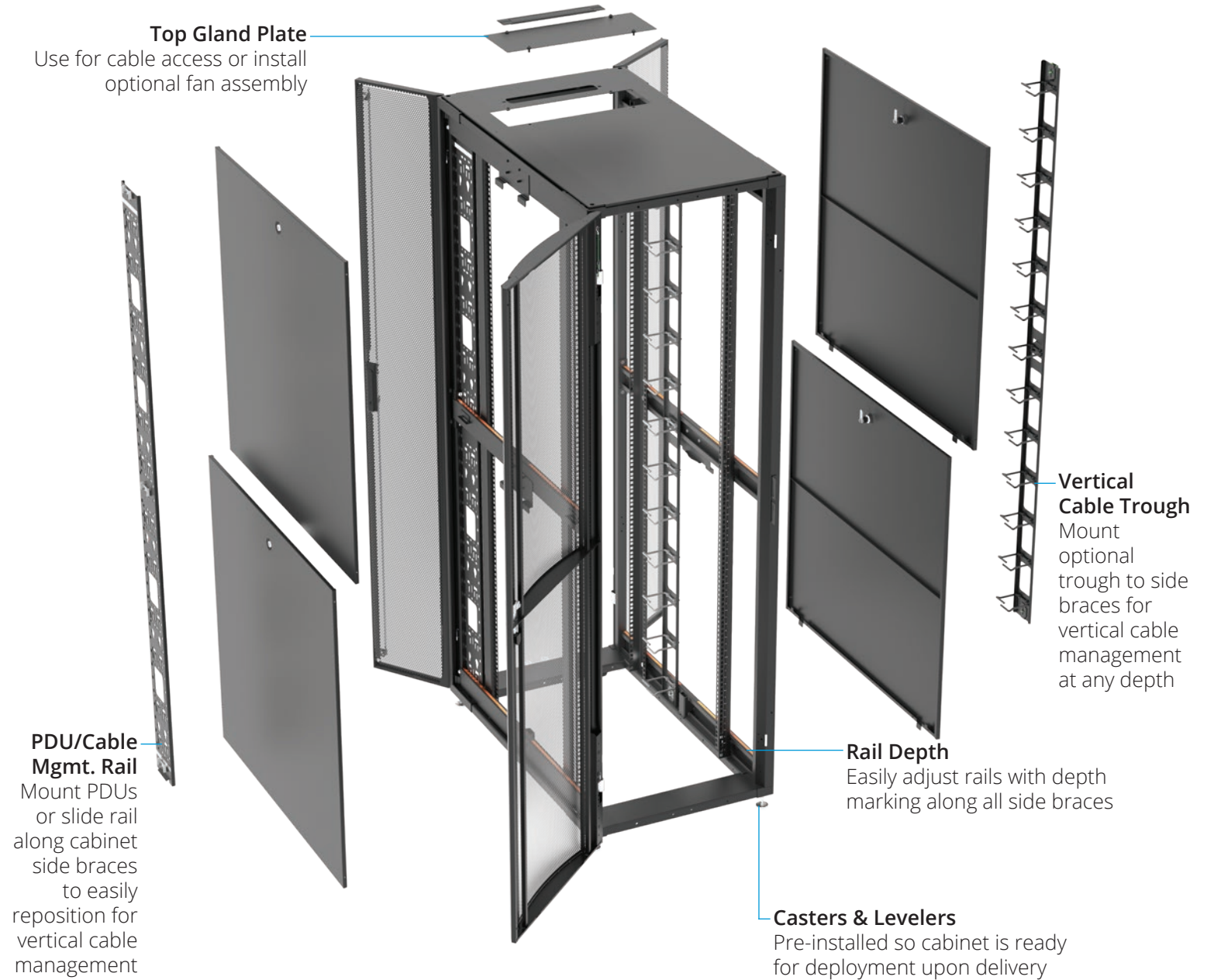

79"H x 24"W x 42"D frame shown

EASY ORDERING AND READY TO "ROLL" UPON DELIVERY

CL CABINETS

DISTINCT SEGREGATION/ACCESS CONTROL TO EACH CABINET BAY

Common cabinet configuration includes:

- Welded frame (including top and bottom) with 19" EIA mounting rails with RMU markings, FMP, and square hole pattern to use with optional ¼ turn "D" rings
- Two pairs of 3/8" sq. (M6) rails in every bay
- Pair of solid tamper resistant side panels (internally secured)
- Adjustable levelers, 2.5"H
- Dedicated cable entry to each bay; entry is from cabinet top unless specified
- Front and rear doors with locking swing handle; unique locking core to each bay
- 'MM' configuration, front and rear mesh doors
- 'PF' configuration, front plexi and rear solid doors (with two fan assembly)
- Color: Black; Custom colors available
- Standards: RoHS II



SEAL Security Ready. Add intelligent access control to create a SEAL® solution! See page 23

Part No.	No. of Bays	RMU/ Bay	H"	W"	D"	Usable Depth"	UL Total Rail Rating lbs.	Total Max Static Weight lbs.
GL8403048CL3MM	3	14	84	30	48	45	1500	2500
GL8403042CL3MM	3	14	84	30	42	39	1500	2500
GL8403036CL3MM	3	14	84	30	36	33	1500	2500
GL8403048CL3PF	3	14	84	30	48	45	1500	2500
GL8403042CL3PF	3	14	84	30	42	39	1500	2500
GL8403036CL3PF	3	14	84	30	36	33	1500	2500
GL8403048CL2MM	2	21	84	30	48	45	1500	2500
GL8403042CL2MM	2	21	84	30	42	39	1500	2500
GL8403036CL2MM	2	21	84	30	36	33	1500	2500
GL8403048CL2PF	2	21	84	30	48	45	1500	2500
GL8403042CL2PF	2	21	84	30	42	42	1500	2500
GL8403036CL2PF	2	21	84	30	36	33	1500	2500

For cabinet extras (hardware, bus bars, etc.), see page 57; for 19" cable organizers, filler panels and other rack mount accessories, see page 135

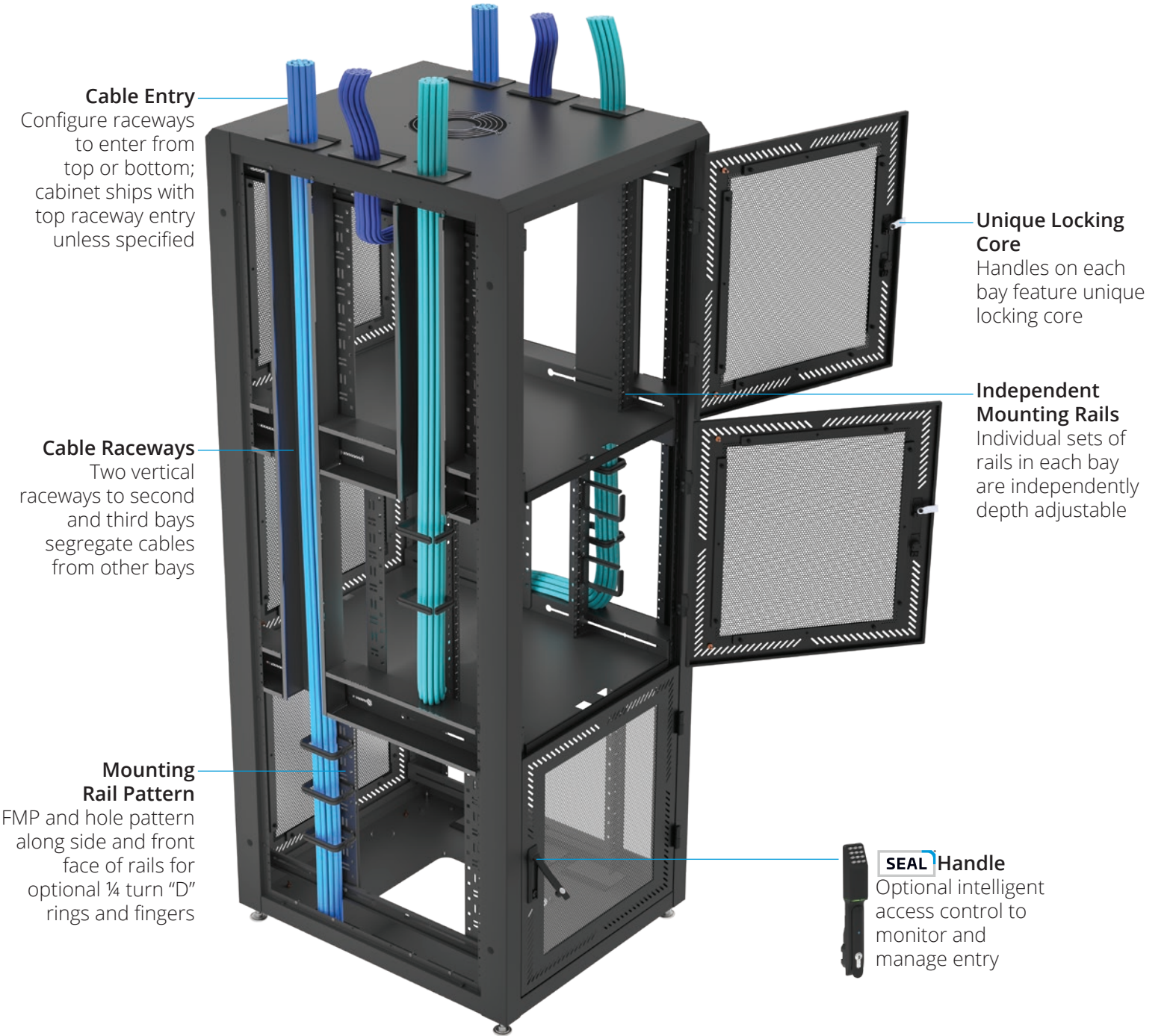

Cable Entry
Configure raceways to enter from top or bottom; cabinet ships with top raceway entry unless specified

Cable Raceways
Two vertical raceways to second and third bays segregate cables from other bays

Mounting Rail Pattern
FMP and hole pattern along side and front face of rails for optional ¼ turn "D" rings and fingers

Unique Locking Core
Handles on each bay feature unique locking core

Independent Mounting Rails
Individual sets of rails in each bay are independently depth adjustable

SEAL Handle
Optional intelligent access control to monitor and manage entry

84"H x 30"W x 36"D frame shown

SECURE FEATURES IN EVERY BAY TO PROTECT CUSTOMERS AND EQUIPMENT

EZ CABINETS

ROBUST & ACCESSORY-RICH CABINET TO PROTECT AGAINST SEISMIC ACTIVITY

'EZ' Cabinet Configuration includes:

- Welded frame with two pairs of 19" EIA mounting rails with RMU markings and FMP - 3/8" sq. (M6) rails installed
- Two pairs of PDU brackets to accept vertical cable troughs (VCT), vertical cable bars (VCB), and/or PDUs
- Solid top panel
- Pair of solid, tamper resistant side panels (internally secured)
- Seismic anchor kit with 4-torque controlled expansion anchors
- Front and rear mesh doors with locking swing handle and 3-point latch
- Color: Black; Custom colors available
- Standards: GR-63-CORE*, RoHS II



SEAL Security Ready. Add intelligent access to create a SEAL® solution! See page 23

Part No.	RMU	H"	W"	D"	Usable D"	Seismic Rail Rating lbs.	Max. Static Weight lbs.
GL840EZ-3042S	44	84	30	42	40	1000*	5000
GL840EZ-2448S	44	84	24	48	46	1000	5000
GL840EZ-2442S	44	84	24	42	40	1000	5000
GL790EZ-3042S	42	79	30	42	40	1000	5000
GL790EZ-2448S	42	79	24	48	46	1000	5000

* GL840EZ-3042S is GR-63-CORE certified

For cabinet extras (hardware, bus bars, etc.), see page 57; for 19" cable organizers, filler panels and other rack mount accessories, see page 135

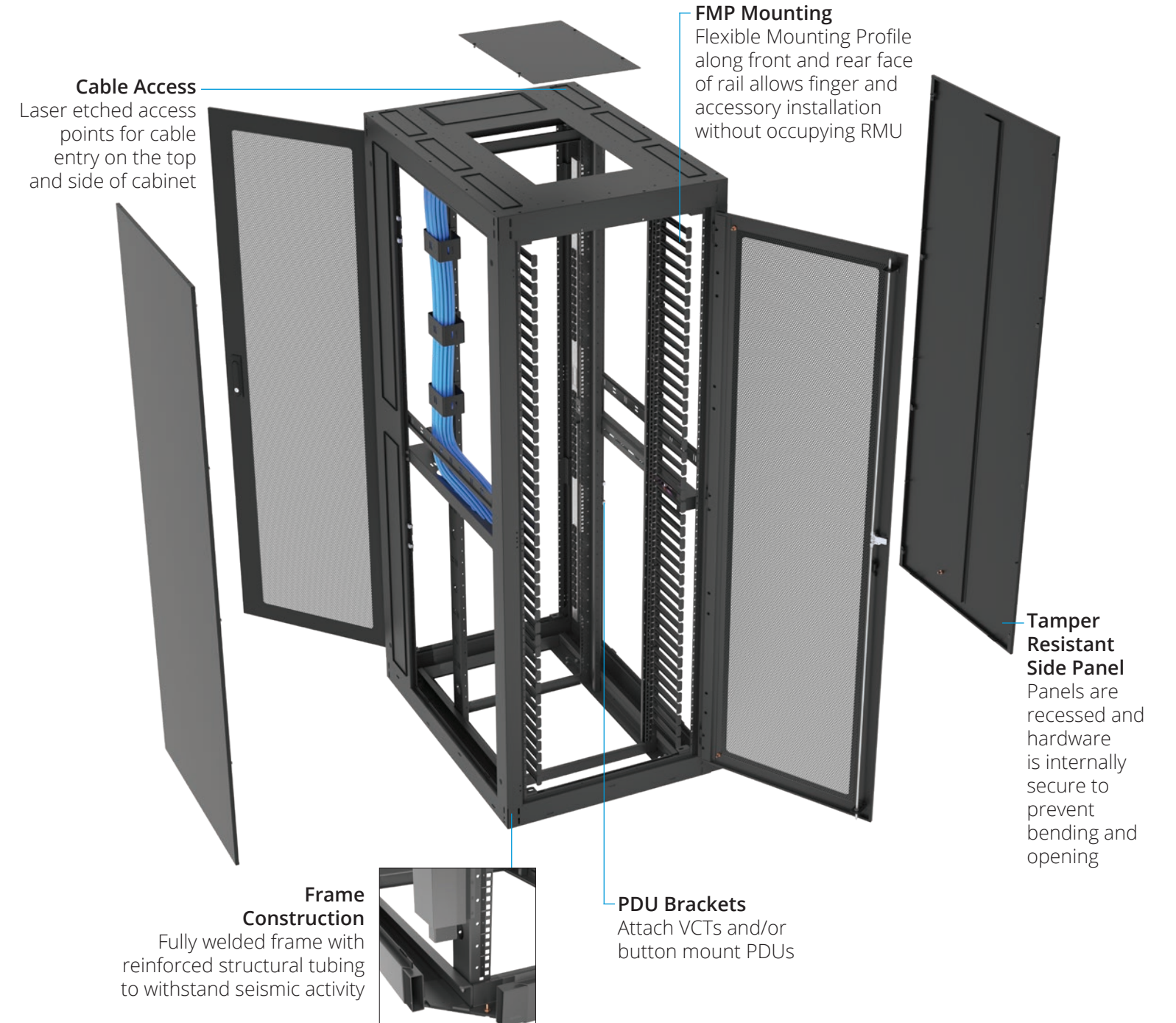

84"H x 30"W x 42"D frame shown, six top cabinet knockouts are part of 30" frames only

AIRFLOW, CABLE MANAGEMENT, SECURITY - ALL WITH THE MOST RIGID CONSTRUCTION

NEMA 12K CABINETS

MADE FOR HARSH INDOOR ENVIRONMENTS

'N12' Cabinet Configuration includes:

- Welded frame with 19" EIA mounting rails with RMU markings and FMP (FMP on 30"W only)
 - 3/8" sq. (M6) rails installed; choose tapped #10-32 at no charge
- Vertical lacing bar with keyhole pattern for button mounting PDUs and obround pattern for cinch straps; one in each rear corner
- Screw-on side panels: solid and sides with removable gland plate for optional AC units:
 - Side panel "A" accepts 2500 to 6000 BTU AC
 - Side panel "B" accepts 10000 to 12000 BTU AC
 - Side panel "C" accepts 14000 to 20000 BTU AC
- Internal intake and exhaust baffle to direct AC airflow (included with AC panel)
- Front and rear solid doors with removable gland plate for optional filter/fan assembly
 - Locking handle with 3-point latch
- Four top, lifting eye bolts
- Color: Black; Custom colors available
- Standards: UL508A, NEMA 250 Type 12K, RoHS II



Part No.	RMU	H"	W"	D"	Usable Depth"	Side Panel	Max. Static Weight lbs.
GL840N12-3042-SS	45	84	30	42	42	Two solid sides	4000
GL840N12-3042-SA	45	84	30	42	42	Solid and panel "A"	4000
GL840N12-3042-SB	45	84	30	42	42	Solid and panel "B"	4000
GL840N12-3042-SC	45	84	30	42	42	Solid and panel "C"	4000
GL840N12-2442-SS	45	84	24	42	42	Two solid sides	4000
GL840N12-2442-SA	45	84	24	42	42	Solid and panel "A"	4000
GL840N12-2442-SB	45	84	24	42	42	Solid and panel "B"	4000
GL840N12-2442-SC	45	84	24	42	42	Solid and panel "C"	4000

For NEMA AC units and filter/fan assemblies, see page 56; for cabinet extras (hardware, bus bars, etc.), see page 57; for 19" cable organizers, filler panels and other rack mount accessories, see page 135

Handle with 3-Point Latch
Latch on front and rear doors maximize compression with the frame

Fan Assembly
Optional fan draws ambient air into the cabinet while it passes through a filter to maintain NEMA 12 rating*

Conduit Knockouts
Multiple 2" knockouts on top and bottom of cabinet for cable entry

Exhaust Filter
Optional filter allows exhaust to exit the cabinet while maintaining NEMA 12 rating*

Internal Airflow
AC side panels feature an internal baffle to direct conditioned air to the front of equipment and exhaust returns to the AC*

Rail Cable Mgmt.
FMP along front face of rails to mount cable fingers without occupying RMU

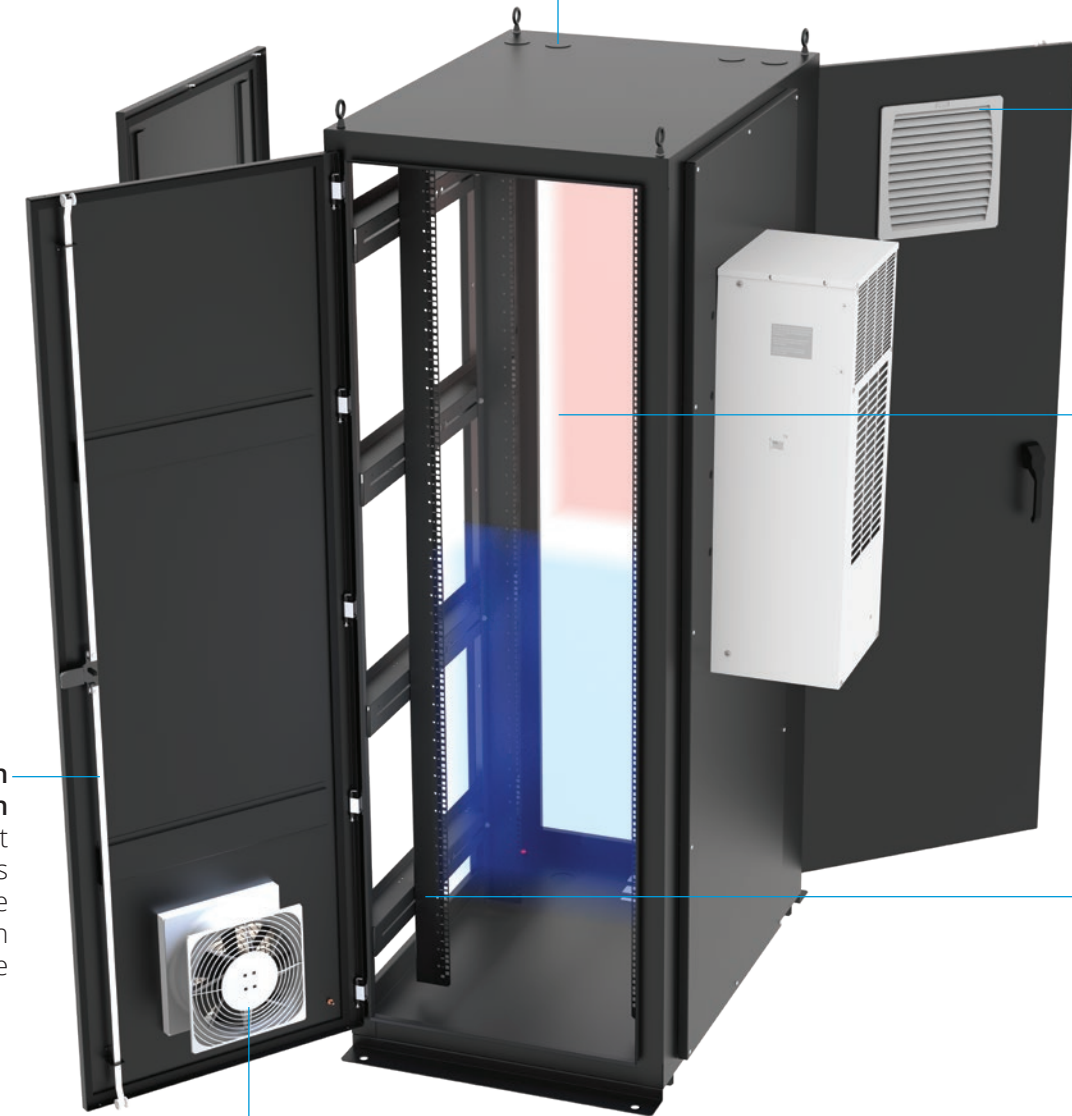

84"H x 30"W x 42"D frame shown; *fan assembly and exhaust filters cannot be used in conjunction with AC units

UL AIRFLOW OPTIONS MAINTAIN NEMA 12 RATING AND CABINET INTEGRITY

NEMA AIRFLOW

Part No.	Description	Compatible Cabinet
AC UNITS FOR NEMA 12K CABINET		
Ice Qube® AC unit for vertical mounting; manufacturer's warranty applies		
GL2500V	2500 BTU; 120V, 7.3 amps	N12 cabinet w/ side "A"
GL3500V	3500 BTU; 120V, 8.2 amps	N12 cabinet w/ side "A"
GL4500V	4500 BTU; 120V, 9.5 amps	N12 cabinet w/ side "A"
GL6000V	6000 BTU; 120V, 10.9 amps	N12 cabinet w/ side "A"
GL10000V	10000 BTU; 120V, 15.1 amps	N12 cabinet w/ side "B"
GL12000V	12000 BTU; 120V, 19.6 amps	N12 cabinet w/ side "B"
GL14000V	14000 BTU; 15.0-16.5 amps	N12 cabinet w/ side "C"
GL17000V	17000 BTU; 230V, 15.5/17.1 amps	N12 cabinet w/ side "C"
GL20000V	20000 BTU; 230V, 18.2/20 amps	N12 cabinet w/ side "C"

Part No.	Description	Compatible Cabinet
FAN ASSEMBLIES FOR NEMA 12K CABINET		
Fan assembly (includes filter) and exhaust filter, 115V		
FFKN12-A1	230 CFM, 52/54 dB(A)	All N12 sizes
FFKN12-A2	295 CFM, 63/64 dB(A)	All N12 sizes
FFKN12-A3	368 CFM, 66/69 dB(A)	All N12 sizes
FILTER-09	Pack of five filters	All N12 sizes

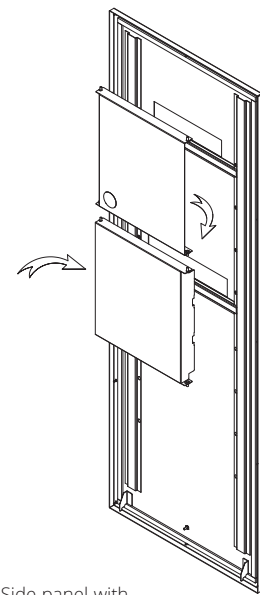

N12 Side panel with included baffles (A, B or C)

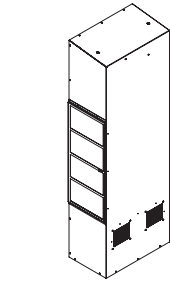

GL6000V, 10000V

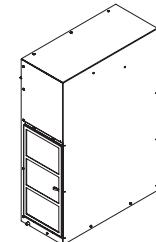

GL2500V, 3500V, 4500V

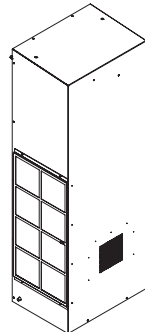

GL12000V+

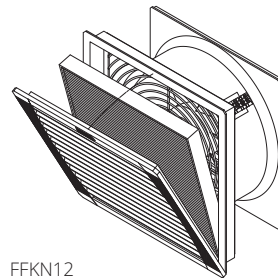

FFKN12

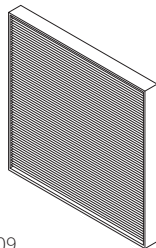

FILTER-09

CABINET EXTRAS

Part No.	Description	Compatible Cabinet
19" MOUNTING RAILS		
9105-ES2P	3/8" sq. (M6) rails with FMP, pair	91"H ES sizes
9105-ES1P	#10-32 rails with FMP, pair	91"H ES sizes
8405-ES2P	3/8" sq. (M6) rails with FMP, pair	84"H ES & E sizes
8405-ES1P	#10-32 rails with FMP, pair	84"H ES & E sizes
8405-N1224	#10-32 rails, pair	24"W N12 sizes
8405-N1230	#10-32 rails with FMP, pair	30"W N12 sizes
7905-ES2P	3/8" sq. (M6) rails with FMP, pair	79"H ES sizes
7905-ES1P	#10-32 rails with FMP, pair	79"H ES sizes
7205-ES2P	3/8" sq. (M6) rails with FMP, pair	72"H E sizes
7205-ES1P	#10-32 rails with FMP, pair	72"H E sizes
6005-E29	3/8" sq. (M6) rails with FMP, pair	60"H E sizes
4805-E2P	3/8" sq. (M6) rails with FMP, pair	48"H E sizes
3005-E2P	3/8" sq. (M6) rails with FMP, pair	30"H E sizes

Mounting Rails



E23K-XX

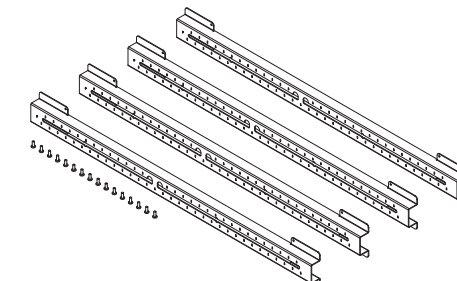

2319

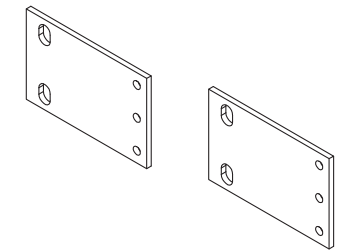

Part No.	Description	Compatible Cabinet
23" & 19" MOUNTING CONVERSION		
ES23K-42	Kit to convert from 19" to 23" mounting	30"W ES sizes
E23K-36	Kit to convert from 19" to 23" mounting	29"W x 36"D E sizes
E23K-32	Kit to convert from 19" to 23" mounting	29"W x 32"D E sizes
2319	Pair of recessed reducer brackets, 23" to 19", 8.625"H	23" EIA mounting
2319-F	Pair of flush reducer brackets, 23" to 19", 5.25"H	23" EIA mounting
2319F1.75	Pair of flush reducer brackets, 23" to 19", 1.75"H	23" EIA mounting

Part No.	Description
RACK MOUNT HARDWARE, PACKAGE OF 50	
HDW-106-50	M6 cage nuts with #10-32 x 1/2" screws
HDW-105-50	M6 cage nuts with M6 screws, 12mm
HDW-105-50L	M6 cage nuts with M6 screws, 20mm
HDW-102-50	Pan head Phillips, #10-32 x 1/2" screws

CABINET EXTRAS

Part No.	Description	Compatible Cabinet
----------	-------------	--------------------

COPPER BUS BARS

CBB-19	19" mounting	All cabinets; ideal for CL sizes
CBB-30	25"L bar	30"H E sizes
CBB-48	43.5"L bar	48"H ES & E sizes
CBB-60	58"L bar	60/72"H E sizes
CBB-72	66"L bar	All 79/84"H sizes (excluding CL)
CBB-78	76"L bar	All 91"H sizes

Part No.	Description	Compatible Cabinet
----------	-------------	--------------------

GANGING KITS

G101ES	Internal hardware for ganging cabinet frames	All ES & EZ sizes
G101	Internal hardware for ganging cabinet frames	All E & CL sizes
G101L	External hardware for ganging cabinet frames	All L sizes

Part No.	Description	Compatible Cabinet
----------	-------------	--------------------

CASTERS, LEVELERS, AND ANCHORS

7208-ES	Set of 4 non-locking stem casters	All ES sizes
7208-E	Set of plate casters, 2 locking, 2 non-locking	All E & CL sizes
7208-EALL	Set of 4 plate casters, all locking	All E & CL sizes
7209-HD	Set of 4 adjustable levelers, 2.5"H	All ES, E, & CL sizes
7209-4HD	Set of 4 adjustable levelers, 4"H	All ES, E, & CL sizes
AK101	Seismic anchor kit, four torque controlled expansion anchors	All ES, E, CL, EZ & N12 sizes

Part No.	Description	Compatible Cabinet
----------	-------------	--------------------

DOOR HANDLES

CH-03	Locking swing handle to accept hasp lock	All ES, E & CL sizes
CH-04	Swing handle to accept hasp lock	All ES, E & CL sizes
CH-06	Locking swing handle with 4-digit combination	All ES, E & CL sizes
GL-KEYS	Set of 2 keys; identify key code at time of order	N/A
SEAL Solutions	Multiple intelligent access options provide increased security to monitor and manage user access; see page 23 for options	All ES, E & CL sizes

We rack your world.

MOUNT IT UP.

We get it. Your office real estate is at a premium. No sense giving it up for a bunch of computers and cables.

That's why we build wall mounts that fit neatly into small spaces. And hold lots of stuff. Sometimes really heavy stuff.

We can rack your world with wall mounts for any need. With loads of amazing features. Like vertical cable bars. Integrated cinch straps. Tilt and stagger brackets. Or intelligent access control.

Wall mounts that are fast, flexible and easy? Why not.

***“If your wall can handle
the weight, our wall
mount can, too.”***

Vitaliy Lisichenko - Engineer

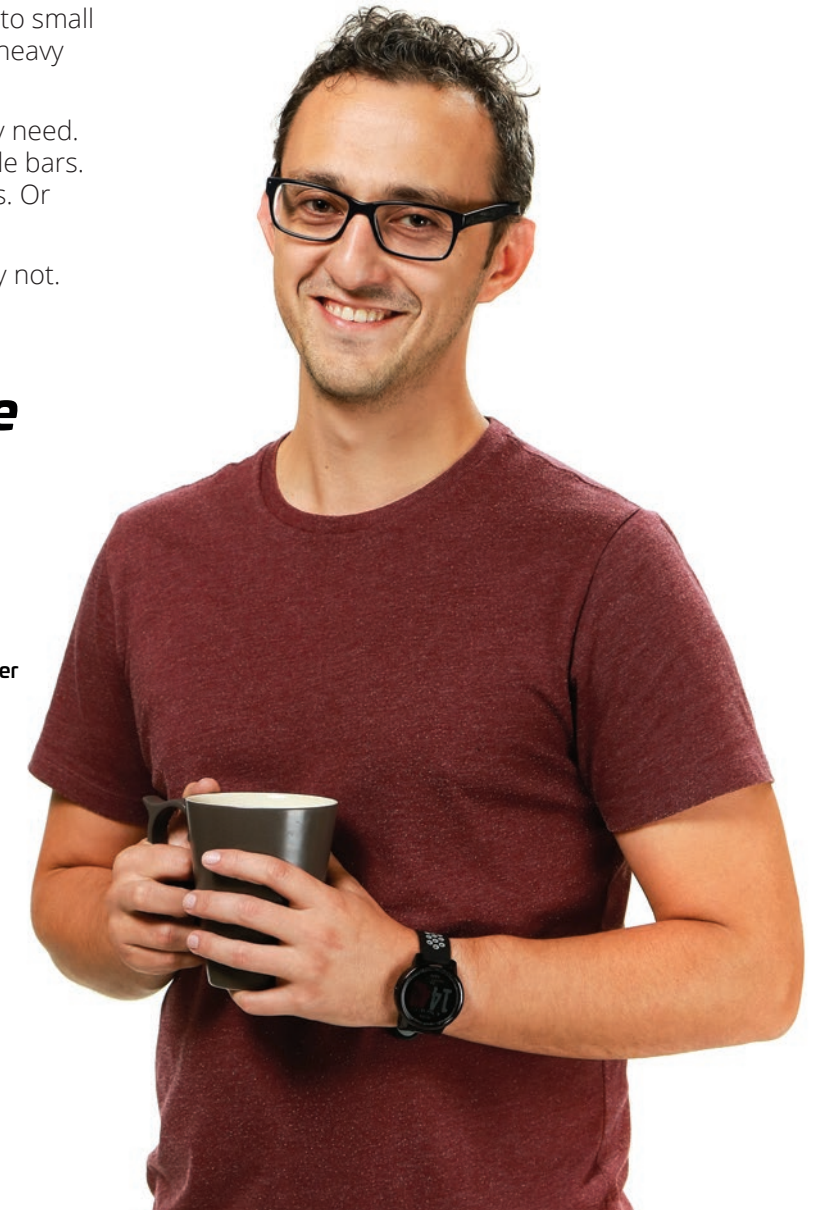

GreatCabinets.com

WALL MOUNT CHOICES



	PREMIUM				STANDARD				SPECIALTY		
	WMCM	WDX	WLP	NEMA 12K	WM	WD	SR	SRD	WE	WR	15WM
Key Features	Unique cable management features	Strong and secure	Unique features for zone cabling	Constructed for harsh indoor environments	Standard wall mount features	Standard features with more depth	Standard swing frame	Swing frame with more depth	Side mounting of servers	Ideal for small AV applications	Ideal for small AV applications
Physical Security	SEAL Security Ready	SEAL Security Ready	SEAL Security Ready	Standard key lock	Standard key lock	Standard key lock	N/A	N/A	Standard key lock	N/A	Standard key lock
RMU	12, 19, 25	11, 18, 25	10 RMU along brackets	12, 19, 26	12, 19, 25	11, 18, 25	12, 19, 26	12, 19, 26	10	2, 4	7
Height (in.)	24, 36, 48	24, 36, 48	24, 36, 48	24, 36, 48	24, 36, 48	24, 36, 48	24, 36, 48	24, 36, 48	24	4, 7.5	15
Width (in.)	24	24	27	24	21.25	24	20.75	20.75	36	20	22
Depth (in.)	30.54	32	10	24, 30	24.5 (GL2418WM: 18)	32	18	24	21	22	18
Usable Depth (in.)	28	28	21, 33, 45	22, 28	22 (GL2418WM: 15.5)	30	16	22	34	21	17
Weight Capacity (lbs.)	200, 250, 300	250, 300, 350	105, 105, 150	150, 250, 300	150, 250, 350	250, 300, 350	50	100	350	50, 75	100
Max Rail Space (in.)	23	21	N/A	17, 23	17.62 (GL2418WM: 11.06)	23	N/A	N/A	29	N/A	N/A
19" Mounting Rails	#12-24; 2 pair, fully adjustable	3/8" sq. (M6); 2 pair, fully adjustable	Adjustable #12-24 brackets for 19 or 23" mtg.	#12-24; 2 pair, fully adjustable	#12-24; 2 pair, fully adjustable	#12-24; 2 pair, fully adjustable	#12-24; 1 pair tapped front and rear	#10-32; 1 pair	3/8" sq. (M6); 2 pair, fully adjustable	#12-24, 1 pair, adjustable to 3 positions	#10-32; 1 pair
Front Door Options	Plexi, mesh, solid	Plexi, mesh, solid	Perforated steel	Solid	Plexi, mesh, solid	Plexi, mesh, solid	N/A	N/A	Mesh	N/A	Plexi, mesh
Reversible Mounting	Yes	Yes	Yes	Yes	Yes	Yes	Yes	Yes	Yes	N/A	Yes
Conduit Knockouts	1, 2, 3" Nominal concentric	1, 2, 3" Nominal concentric	1, 2, 3" Nominal concentric; 1 and 2" nominal	2" Nominal	1, 2, 3" Nominal concentric; horseshoe knockout	1, 2, 3" Nominal concentric	N/A	N/A	1, 2, 3" Nominal concentric	N/A	.5 and .75, 1 and 1.5 nominal concentric
Cable Management Options	- Horizontal cable organizers - ¼ turn "D" rings for rails - Vertical cable bar	Horizontal cable organizers	- Horizontal cable organizers - Cable rings and fiber boxes	Horizontal cable organizers	Horizontal cable organizers	Horizontal cable organizers	- Horizontal cable organizers - Obround pattern for cinch straps	- Horizontal cable organizers - Obround pattern for cinch straps	Horizontal cable organizers	- Provisions for cable cinch straps	Horizontal cable organizers
Airflow Options	- 2 fan unit - Dust kit	- 2 fan unit - Dust kit	Single fan	- Filter/fan or AC unit - N12 units accept filter/fan - N12A units accept AC* (cannot be reversed)	- 2 fan unit - Dust kit	- 2 fan unit - Dust kit	N/A	N/A	2 fan unit	Single fan unit	Single fan unit
Color	Black, Winter White	Black	Black	Black	Black	Black	Black	Black	Black	Black	Black
Standards	UL2416, RoHS II	UL2416, RoHS II	UL2416, RoHS II	UL508A, NEMA 250 Type 12, RoHS II	UL2416, RoHS II	UL2416, RoHS II	UL2416, RoHS II	UL2416, RoHS II	UL2416, RoHS II	UL2416, RoHS II	UL2416, RoHS II

WMCM

UNIQUE CABLE MANAGEMENT FEATURES

- Two pair of #12-24 tapped mounting rails (depth adjustable)
- Offset mounting rails create nearly 3.5" of dedicated cable management space between the rail and side
- Rails feature a horizontal/vertical cable tie down pattern and provisions for optional cable management "D" rings
- Nominal concentric conduit knockouts on top, bottom, and back of rear section
- Provisions on top and bottom for fan assembly
- 150mm x 25mm Standard door handle cutout; easily install other handle options for increased security
- Reversible mounting for left-hand or right-hand opening
- Color: Black, Winter White
- Standards: UL2416, RoHS II



SEAL Security Ready. Add intelligent access control to create a SEAL® solution! See page 23

Part No.	RMU	H"	W"	D"	Usable Depth"	Max. Rail Spacing"	Weight Capacity lbs.	Door
GL24WMCM	12	24	24	31	28	23	200	plexi
GL24WMCMM	12	24	24	31	28	23	200	mesh
GL24WMCMS	12	24	24	31	28	23	200	solid
GL36WMCM	19	36	24	31	28	23	250	plexi
GL36WMCMM	19	36	24	31	28	23	250	mesh
GL36WMCMS	19	36	24	31	28	23	250	solid
GL48WMCM	25	48	24	31	28	23	300	plexi
GL48WMCMM	25	48	24	31	28	23	300	mesh
GL48WMCMS	25	48	24	31	28	23	300	solid

WMCM Accessories

- VCB24WMCM Vertical cable bar installs on hinge support brackets in rear section; use with optional ¼ turn "D" rings
- VCB36WMCM Vertical cable bar installs on hinge support brackets in rear section; use with optional ¼ turn "D" rings
- VCB48WMCM Vertical cable bar installs on hinge support brackets in rear section; use with optional ¼ turn "D" rings

Vertical Cable Bar
Optional bar shown with 3.5" x 5", ¼ turn "D" rings

Mounting Rail Pattern
Cable tie down pattern and provisions for optional 1.5" x 3.5"; ¼ turn "D" rings

SEAL Handle
Optional intelligent access control to monitor and manage entry

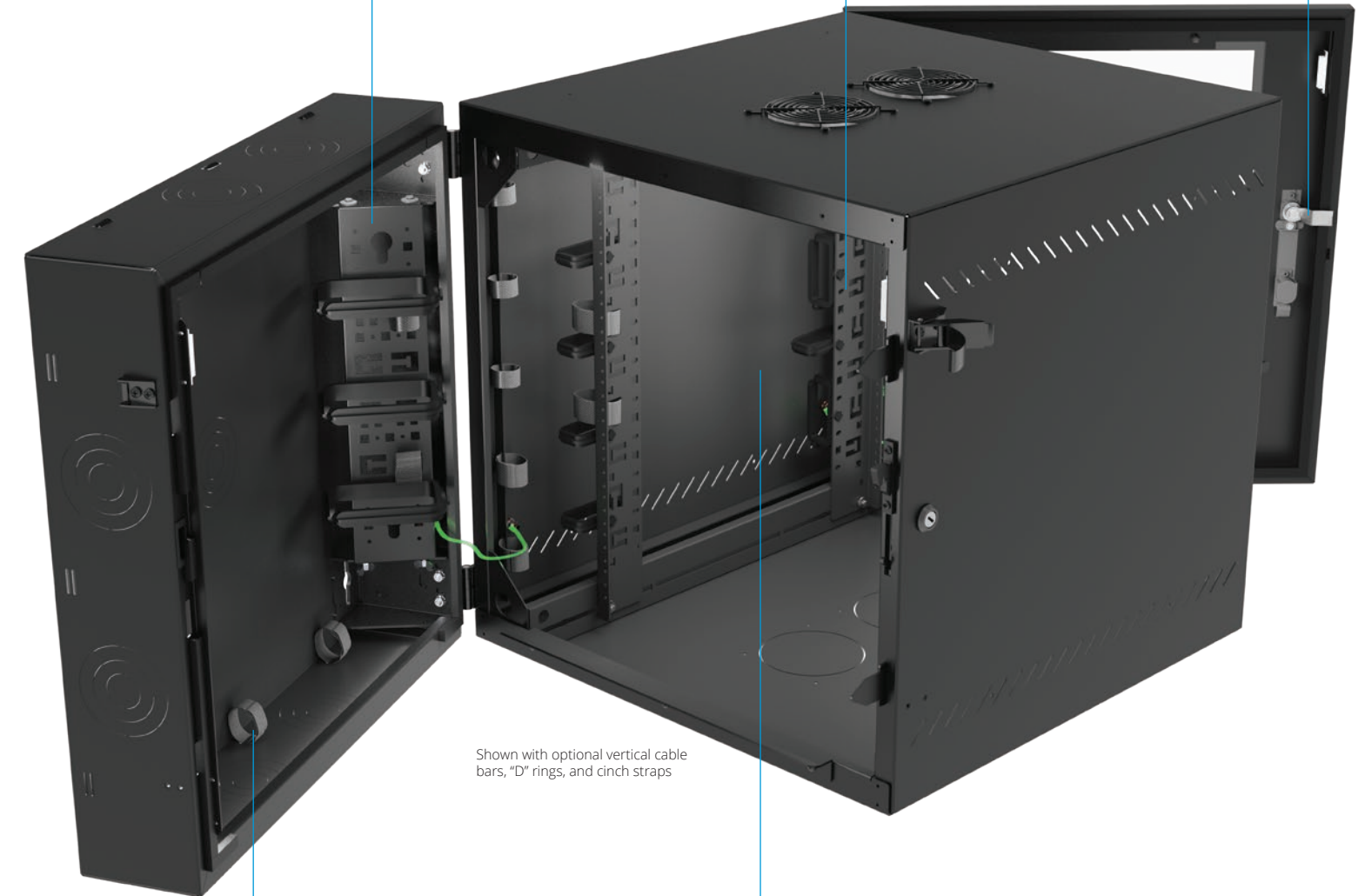

Shown with optional vertical cable bars, "D" rings, and cinch straps

Cinch Straps
Provisions in multiple locations for optional straps

Dedicated Cable Space
3.5" of open space between the rail and side for better cable management

WDX

STRONG AND SECURE

- Two pair of 3/8" sq. (M6) mounting rails (depth adjustable)
- Front pair of rails is part of a depth adjustable inner frame that provides increased support for heavy equipment
- Removable rectangular gland plate on top of the rear section features nominal concentric conduit knockouts
- Removable gland plate on top of center section for fan assembly
- 150mm x 25mm Standard door handle cutout; easily install other handle options for increased security
- Reversible door for left-hand or right-hand opening
- Welded back panel and support "shelf" completely eliminates deflection
- Color: Black
- Standards: UL2416, RoHS II



SEAL Security Ready. Add intelligent access control to create a SEAL® solution! See page 23

Part No.	RMU	H"	W"	D"	Usable Depth"	Max. Rail Spacing"	Weight Capacity lbs.	Door
GL24WDX	11	24	24	32	28	21	250	plexi
GL24WDXM	11	24	24	32	28	21	250	mesh
GL24WDXS	11	24	24	32	28	21	250	solid
GL36WDX	18	36	24	32	28	21	300	plexi
GL36WDXM	18	36	24	32	28	21	300	mesh
GL36WDXS	18	36	24	32	28	21	300	solid
GL48WDX	25	48	24	32	28	21	350	plexi
GL48WDXM	25	48	24	32	28	21	350	mesh
GL48WDXS	25	48	24	32	28	21	350	solid

Gland Plate
Features concentric conduit knockouts

90° Stop Arm
Ensures wall mount remains supported

SEAL Handle
Optional intelligent access control to monitor and manage entry

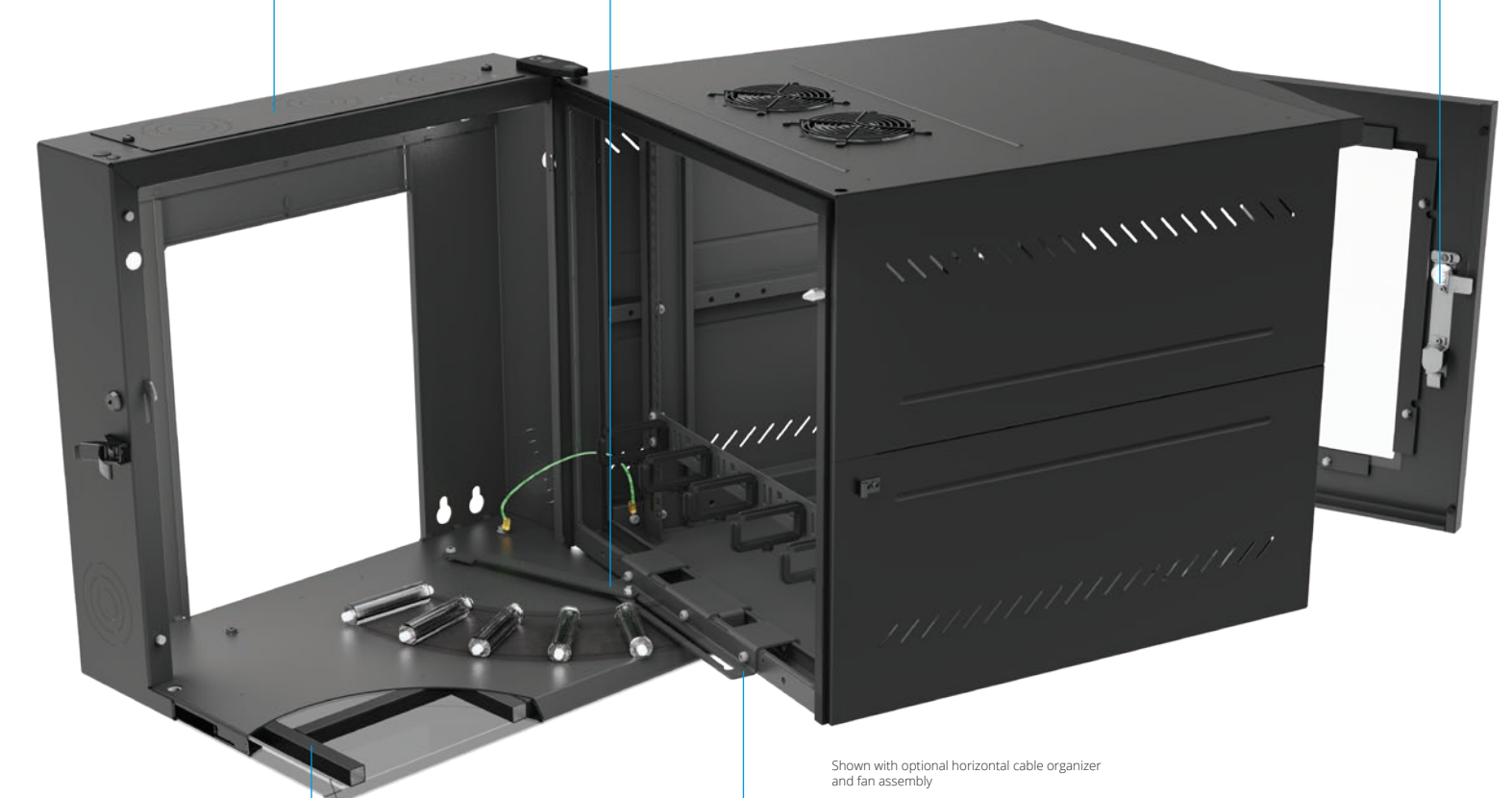

Support Shelf
Welded shelf eliminates deflection

Center Support Roller
for easy rear access (pivot travel shown)

Shown with optional horizontal cable organizer and fan assembly

WLP

UNIQUE FEATURES FOR ZONE CABLING

- #12-24 tapped mounting brackets (19 or 23" mounting) that can be vertically adjusted
- One pair of 4 RMU tilt brackets (WLPTOB) provide rear equipment access for punch down termination and one pair of stagger brackets (WLPSB) with up to 6 RMU of mounting space
- Multiple nominal concentric conduit knockouts on top, bottom, sides, and back
- Provisions on bottom for fan assembly
- 150mm x 25mm Standard door handle cutout; easily install other handle options for increased security
- Reversible mounting for left-hand or right-hand opening
- Color: Black
- Standards: UL2416, RoHS II



SEAL Security Ready. Add intelligent access control to create a SEAL® solution! See page 23

Part No.	RMU	H"	W"	D"	Usable Depth"	Max. Rail Spacing"	Weight Capacity lbs.	Door
GL24WLP	6-10+	24	27	10	21	N/A	105	vented
GL36WLP	6-10+	36	27	10	33	N/A	105	vented
GL48WLP	6-10+	48	27	10	45	N/A	150	vented

WLP Accessories

WLPSB	Stagger bracket set, (top of bracket, 2 RMU; bottom of bracket, 4 RMU) (pictured)
WLPTOB	Tilt-out bracket set, 4 RMU, for installation along mounting profile lances (pictured)
WLPHMB	Hook mounted bracket Set, 1 RMU, for installation along mounting profile lances (pictured)
WLPCR	Cable management ring kit, includes 6 rings; for installation along mounting profile or cable management lances
WLPLHFB	Hook-mounted fiber box assembly for left hand use; for installation along mounting profile or cable management lance
WLPRHFB	Hook-mounted fiber box assembly for right hand use; for installation along mounting profile or cable management lance

Equipment Mounting
Inner and outer lance pattern for 19" or 23" equipment

Cable Ring
WLPCR - optional
Shown with optional powerstrip and fan

SEAL Handle
Optional intelligent access control to monitor and manage entry

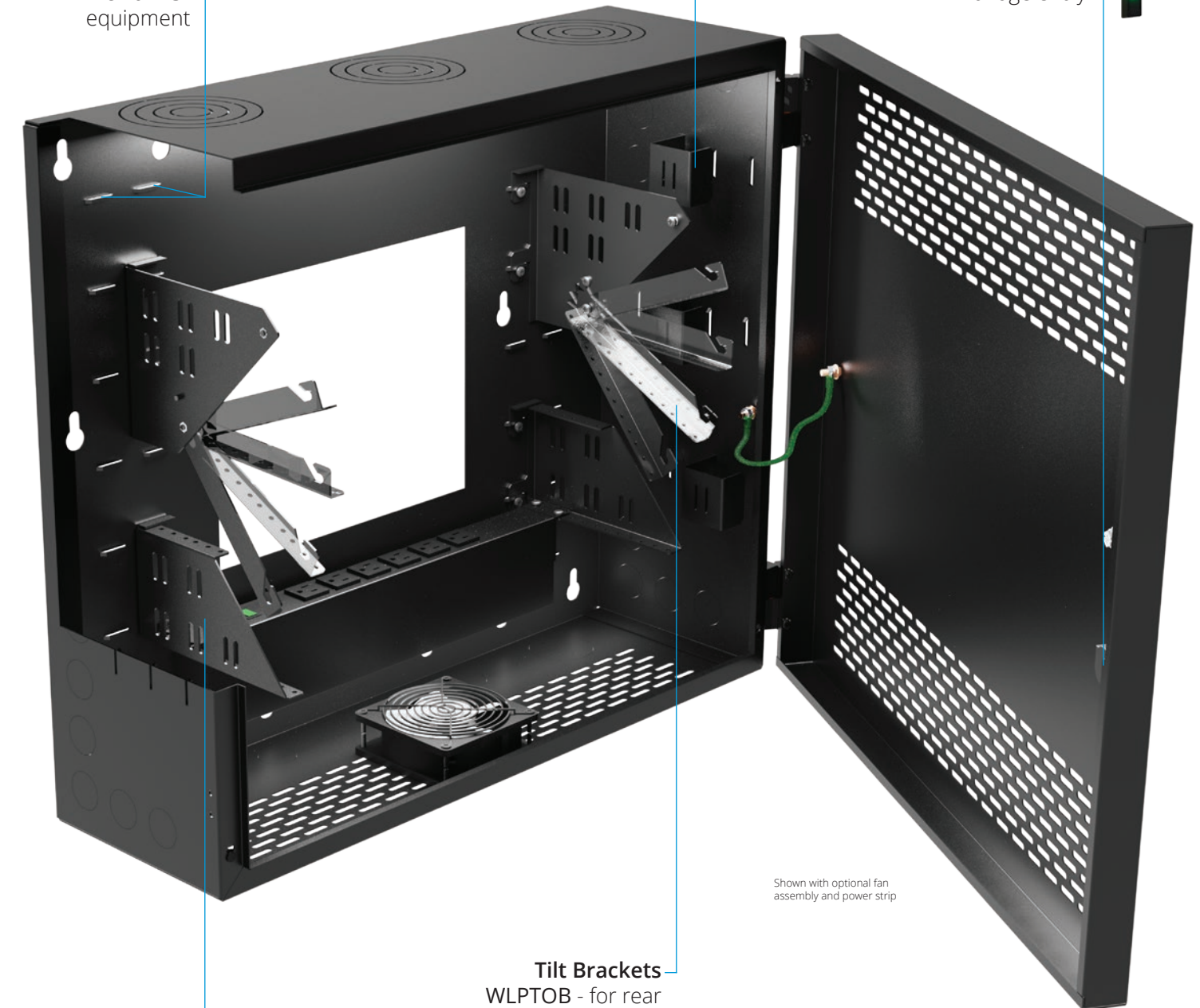

Stagger Brackets
WLPSB - one pair standard

Tilt Brackets
WLPTOB - for rear equipment access; one pair standard (pivot travel shown)

Shown with optional fan assembly and power strip

NEMA 12K

MADE FOR HARSH INDOOR ENVIRONMENTS

- Two pair of #12-24 tapped mounting rails (depth adjustable)
- 2" conduit knockouts on rear section
- Gland plates on center section can be removed for AC unit or intake filter/fan assembly; construction of wall mount varies based on airflow option
- Reversible mounting for left-hand or right-hand opening (N12A units cannot be reversed)
- Front and rear draw latches and "T" handle maximize compression with the center section
- Bulb gasket creates a positive environmental seal for indoor use to protect against ingress of solid foreign objects
- Color: Black
- Standards: UL508A, NEMA 250 Type 12K, RoHS II



Part No.	RMU	H"	W"	D"	Usable Depth"	Max. Rail Spacing"	Weight Capacity lbs.	Door
GL240N12D	12	24	24	30	28	23	150	solid
GL240N12DA*	12	24	24	30	28	23	150	solid
GL240N12	12	24	24	24	22	17	150	solid
GL240N12A*	12	24	24	24	22	17	150	solid
GL360N12D	19	36	24	30	28	23	250	solid
GL360N12DA*	19	36	24	30	28	23	250	solid
GL360N12	19	36	24	24	22	17	250	solid
GL360N12A*	19	36	24	24	22	17	250	solid
GL480N12D	26	48	24	30	28	23	300	solid
GL480N12DA*	26	48	24	30	28	23	300	solid
GL480N12	26	48	24	24	22	17	300	solid
GL480N12A*	26	48	24	24	22	17	300	solid

*N12DA and N12A wall mounts accept AC units; N12 wall mounts accept fan/filter assemblies; see page 77



Cable Access
2" Conduit knockouts

Bulb Gasket
Create positive environmental seal

"T" handle
Maximizes compression of front door

Draw Latches
Maximizes compression of center section

Shown with optional fan and shelf

Airflow Options
Intake fan/filter kit or AC unit (wall mount specific)

WM

STANDARD WALL MOUNT FEATURES

- Two pair of #12-24 tapped mounting rails (depth adjustable)
- Horseshoe knockouts allow already terminated cable to be installed or removed without having to disconnect
- Nominal concentric knockouts on top, bottom, and back of rear section
- Provisions on top and bottom for fan assembly
- Dust kit to protect equipment in contaminated areas
- Independent keyed locks on front door and rear section
- Reversible mounting for left-hand or right-hand opening
- Color: Black
- Standards: UL2416, RoHS II



Part No.	RMU	H"	W"	D"	Usable Depth"	Max. Rail Spacing"	Weight Capacity lbs.	Door
GL2418WM	12	24	21	18	16	11	150	plexi
GL2418WMS	12	24	21	18	16	11	150	solid
GL24WM	12	24	21	25	22	18	150	plexi
GL24WMM	12	24	21	25	22	18	150	mesh
GL24WMS	12	24	21	25	22	18	150	solid
GL36WM	19	36	21	25	22	18	250	plexi
GL36WMM	19	36	21	25	22	18	250	mesh
GL36WMS	19	36	21	25	22	18	250	solid
GL48WM	25	48	21	25	22	18	350	plexi
GL48WMM	25	48	21	25	22	18	350	mesh
GL48WMS	25	48	21	25	22	18	350	solid

WD

STANDARD FEATURES WITH MORE DEPTH

- Two pair of #12-24 tapped mounting rails (depth adjustable)
- Nominal concentric knockouts on top, bottom, and back of rear section
- Provisions on top and bottom for fan assembly
- Dust kit to protect equipment in contaminated areas
- Independent keyed locks on front door and rear section
- Reversible mounting for left-hand or right-hand opening
- Color: Black
- Standards: UL2416, RoHS II



Part No.	RMU	H"	W"	D"	Usable Depth"	Max. Rail Spacing"	Weight Capacity lbs.	Door
GL24WD	11	24	24	32	30	23	250	plexi
GL24WDM	11	24	24	32	30	23	250	mesh
GL24WDS	11	24	24	32	30	23	250	solid
GL36WD	18	36	24	32	30	23	300	plexi
GL36WDM	18	36	24	32	30	23	300	mesh
GL36WDS	18	36	24	32	30	23	300	solid
GL48WD	25	48	24	32	30	23	350	plexi
GL48WDM	25	48	24	32	30	23	350	mesh
GL48WDS	25	48	24	32	30	23	350	solid

SR

STANDARD SWING FRAME

- #12-24 tapped mounting holes on front and rear of frame
- 180° positive stop with stay open hinge pins
- Obround pattern for cable cinch straps

Part No.	RMU	H"	W"	D"	Usable Depth"	Weight Capacity lbs.
GL24SR	12	24	21	18	16	50
GL36SR	19	36	21	18	16	50
GL48SR	26	48	21	18	16	50



SRD

SWING FRAME WITH MORE DEPTH

- #10-32 tapped mounting holes on front of frame
- Increased depth and weight capacity for bigger equipment
- Obround pattern for cable cinch straps

Part No.	RMU	H"	W"	D"	Usable Depth"	Weight Capacity lbs.
GL24SRD	12	24	21	24	22	100
GL36SRD	19	36	21	24	22	100
GL48SRD	26	48	21	24	22	100



WE

SIDE MOUNTING OF SERVERS

- Two pair of 3/8" sq. (M6) mounting rails (depth adjustable)
- Mounts across three studs for increased stability
- Nominal concentric conduit knockouts and provision for fan assembly on top and bottom



Part No.	RMU	H"	W"	D"	Usable Depth"	Max. Rail Spacing"	Weight Capacity lbs.	Door
GL24WE	10	24	36	21	34	29	350	mesh

WR

IDEAL FOR SMALL AV APPLICATIONS

- #10-32 tapped mounting rails are depth adjustable to three positions
- Removable cover provides easier access for equipment installation and maintenance
- Holes for vertical or horizontal wall mounting



Part No.	RMU	H"	W"	D"	Usable Depth"	Max. Rail Spacing"	Weight Capacity lbs.	Door
WR2	2	4	20	22	21	N/A	50	N/A
WR4	4	7	20	22	21	N/A	75	N/A

15WM

IDEAL FOR SMALL AV APPLICATIONS

- One pair of #10-32 tapped mounting rails (depth adjustable)
- A security bit separates the body from the back panel for easy one-person installation
- "Spare" 1 RMU tab on back allows power strip mounting without taking up rail space



Part No.	RMU	H"	W"	D"	Usable Depth"	Max. Rail Spacing"	Weight Capacity lbs.	Door
GL15WM	7	15	22	18	17	N/A	100	plexi
GL15WMS	7	15	22	18	17	N/A	100	solid

WALL MOUNT ACCESSORIES

Part No.	Description	WMCM	WDX	WLP	NEMA	WM	WD	SR	SRD	WE	WR	15WM
AIRFLOW												
7217WS	Fan assembly with two 75 CFM fans	X	X			X	X			X		
7217-04	Fan assembly with one 75 CFM fan			X								X
FFK1	Four fan filters	X	X	X		X	X			X		X
DK1	Dust resistant kit, includes cover plates, fan filters and hardware							X				
DK2	Dust resistant kit, includes cover plates, fan filters and hardware					X						
DK3	Dust resistant kit, includes cover plates, fan filters and hardware	X										
DK4	Dust resistant kit, includes cover plates and hardware		X									
3.50FP19BG	1 RMU filler panel with brush grommet	X	X	X	X	X	X	X	X	X		X
1.75-FP19	1 RMU metal filler panel	X	X	X	X	X	X	X	X	X	X	X
3.50-FP19	2 RMU metal filler panel	X	X	X	X	X	X	X	X	X		X

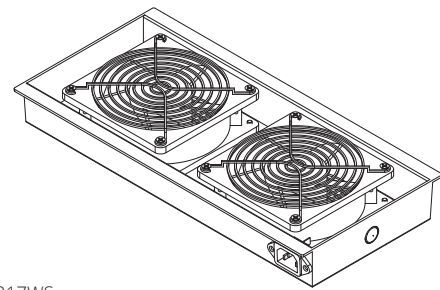

7217WS

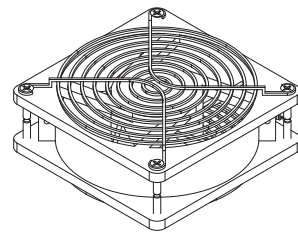

7217-04

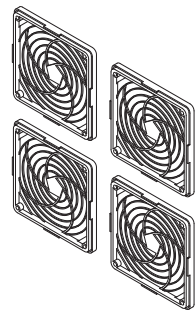

FFK1

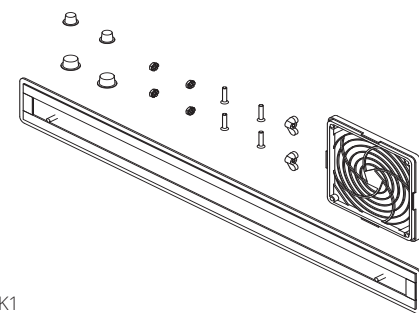

DK1

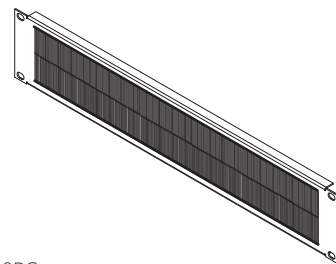

3.50FP19BG

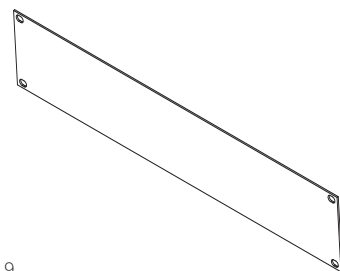

3.50-FP19

WALL MOUNT ACCESSORIES

Part No.	Description
NEMA 12K AIRFLOW - N12A WALL MOUNTS ACCEPT AC UNITS; N12 WALL MOUNTS ACCEPT FAN/FILTER ASSEMBLIES	
GL1000MMR	1000 BTU AC Unit, 120V/60Hz, 3.1 amps, for use with GL240N12A and GL360N12A
GL1300MMR	1300 BTU AC Unit, 120V/60Hz, 3.1 amps, for use with GL240N12A and GL360N12A
GL2200MMR	2200 BTU AC Unit, 120V/60Hz, 3.1 amps, for use with GL480N12A
FFKN12-A4	Fan/filter assembly and exhaust filter, for use with GL240N12, GL360N12 and GL480N12
FILTER-10	Package of five replacement filters for FFKN12-A4, for use with GL240N12, GL360N12 and GL480N12

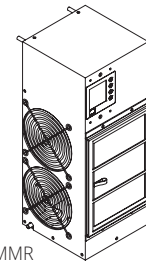

GL1000MMR and GL1300MMR

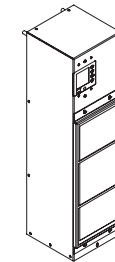

GL2200MMR

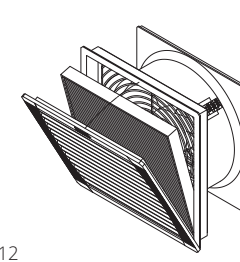

FFKN12

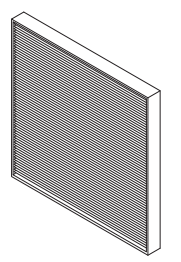

FILTER-10

Part No.	Description	WMCM	WDX	WLP	NEMA	WM	WD	SR	SRD	WE	WR	15WM
CABLE MANAGEMENT												
CM-04	Horizontal cable organizer with five 3.5" x 5", ¼ turn "D" rings; 2 RMU	X	X	X	X	X	X	X	X	X		X
CM-05	Horizontal cable organizer with five 1.5" x 3.5", ¼ turn "D" rings; 1 RMU	X	X	X	X	X	X	X	X	X	X	X
CM-15	Double-sided, horizontal cable organizer with plastic fingers and cover, 2 RMU	X	X	X	X	X	X	X	X	X		X
CM-16	Single-sided, horizontal cable organizer with plastic fingers and cover, 1 RMU	X	X	X	X	X	X	X	X	X	X	X
CM-25	Kit of 10, ¼ turn "D" rings, 1.5" x 3.5"	X										
CM-26	Kit of 10, ¼ turn "D" rings, 3.5" x 5"	X										

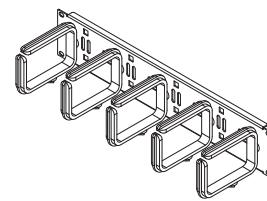

CM-04 (CM-26 ring shown)

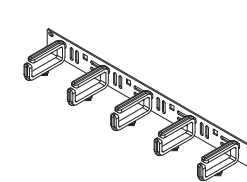

CM-05 (CM-25 ring shown)

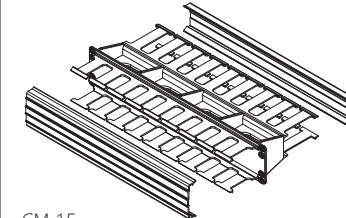

CM-15

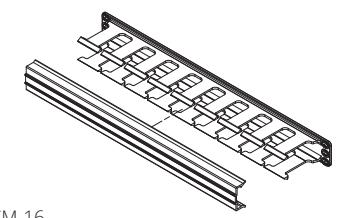

CM-16

WALL MOUNT ACCESSORIES

Part No.	Description	WMCM	WDX	WLP	NEMA	WM	WD	SR	SRD	WE	WR	15WM
7206-14	Stationary shelf, 17.5"W 14"D, 80 lb. weight capacity	X	X		X	X	X	X	X			X
7206-EIA	Stationary shelf, 17.468"W x 18"D, 80 lb. weight capacity	X	X		X	X	X	X	X			
7206-FR-A18	Stationary shelf (front/rear mount adjustable), 17.5"W x 18"D, 150 lb. weight capacity	X	X		X	X	X					
7206-SL	Sliding shelf, 16.343"W x 17.5"D, 40 lb. weight capacity	X	X		X	X	X	X	X			
7206-FRSL-AHD	Sliding shelf (front/rear mount adjustable), 17.5"W x 22"D, 110 lb. weight capacity	X	X				X					

SHELVES

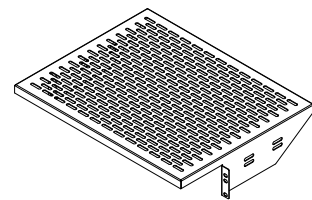

7206-14

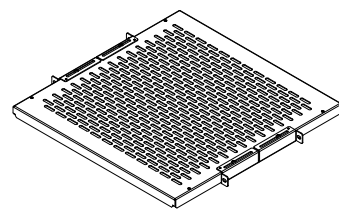

7206-FR

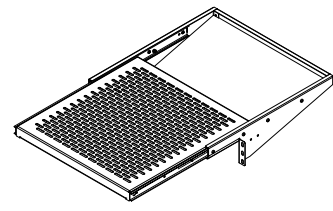

7206-SL

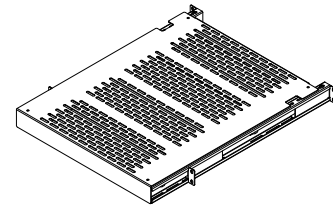

7206-FRSL-AHD

Part No.	Description	WMCM	WDX	WLP	NEMA	WM	WD	SR	SRD	WE	WR	15WM
WMPK-CMD	Wall mount pole kit for use with indoor poles; banding is not provided	X					X					
WMPK	Wall mount pole kit for use with indoor poles; banding is not provided				X	X		X	X			
HDW-102-50	Package of 50, #10-32 x 1/2" Phillips screws								X			X
HDW-107-50	Package of 50 cage nuts with #12-24 x 1/2" Phillips screws		X							X		
HDW-104-50	Package of 50, #12-24 x 1/2" Phillips screws				X	X		X	X			

MOUNTING KIT AND HARDWARE

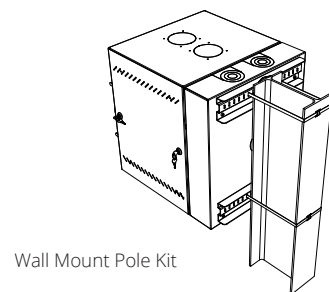

Wall Mount Pole Kit

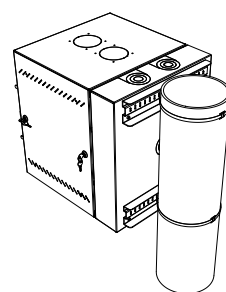

78

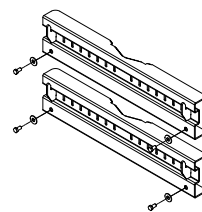

RACK ON.

Sure, a rack is a rack is a rack. Unless it's one of ours.

What makes our racks so great? Simplicity and compatibility. They literally work in any situation. From the smallest, dual purpose room ('cause sometimes the IT and storage closet merge) to the most spacious, techiest data center you can imagine.

And let's not forget these aren't just racks—it's a system.

A system with premium racks. Flexible mounting profiles, interchangeable cable management fingers and rotating rings, mounting options for 19 and 23" equipment.

A system with standard racks. Straightforward and able to be deployed alongside our premium products.

A system with fully assembled vertical cable managers that give you space for cables and even PDUs.

Is there a better rack system on the market? Well, you can look. Or you can save yourself some time and just call us now.

“Our racks will fit your needs today and tomorrow.”

Caius Dunning - Engineer



GreatCabinets.com

We rack your world.

RACK SYSTEM

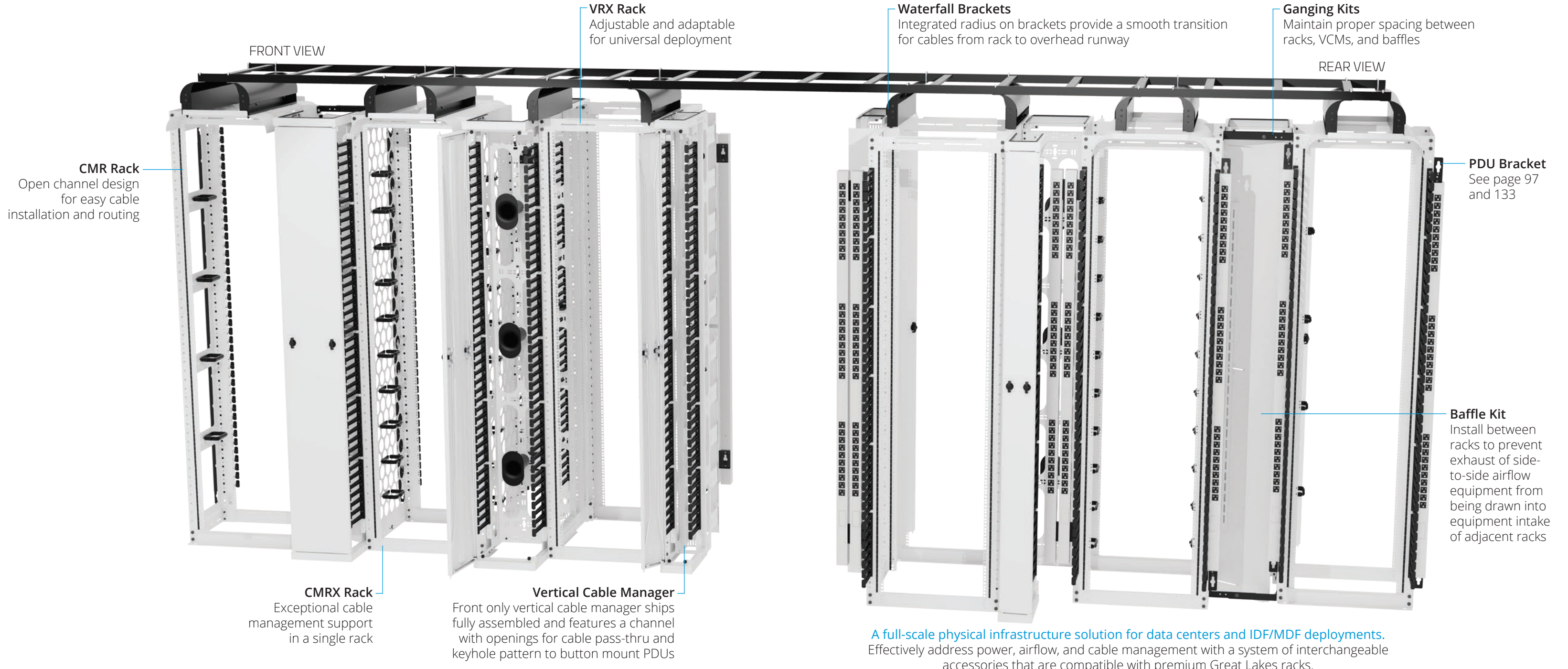

FRONT VIEW

REAR VIEW

CMR Rack
Open channel design for easy cable installation and routing

VRX Rack
Adjustable and adaptable for universal deployment

Waterfall Brackets
Integrated radius on brackets provide a smooth transition for cables from rack to overhead runway

Ganging Kits
Maintain proper spacing between racks, VCMs, and baffles

PDU Bracket
See page 97 and 133

CMRX Rack
Exceptional cable management support in a single rack

Vertical Cable Manager
Front only vertical cable manager ships fully assembled and features a channel with openings for cable pass-thru and keyhole pattern to button mount PDUs

Baffle Kit
Install between racks to prevent exhaust of side-to-side airflow equipment from being drawn into equipment intake of adjacent racks

A full-scale physical infrastructure solution for data centers and IDF/MDF deployments. Effectively address power, airflow, and cable management with a system of interchangeable accessories that are compatible with premium Great Lakes racks.

RACK CHOICES

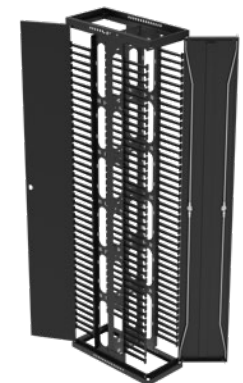
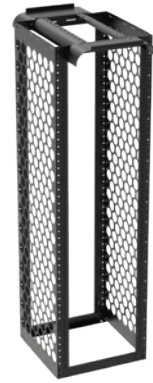

	PREMIUM			STANDARD		CABLE MANAGEMENT		
	CMRX	CMR	VRX	4P	2P	VCM		
Key Features	Exceptional cable management support in a single rack	Open channel design for easy cable installation and routing	Adjustable and adaptable for universal deployment	Effortless rack for server applications	Effortless rack for network applications	Key Features	Fully assembled and ready to accompany any rack	
RMU/Height (in.)	45 RMU / 84"H 52 RMU / 96"H 59 RMU / 108"H	45 RMU / 84"H 52 RMU / 96"H 59 RMU / 108"H	45 RMU / 84"H 52 RMU / 96"H 59 RMU / 108"H	45 RMU / 84"H 52 RMU / 96"H 59 RMU / 108"H	17 RMU / 36"H 24 RMU / 48"H 31 RMU / 60"H 35 RMU / 66"H	38 RMU / 72"H 45 RMU / 84"H 52 RMU / 96"H 59 RMU / 108"H	Height	45 RMU / 84"H 52 RMU / 96"H 59 RMU / 108"H
Width at 19" EIA (in.)	24	24	24	20	20	Width	6, 8, 10, 12	
Width at 23" EIA (in.)	28	28	28	24.3	24.3	Footprint Depth, Front/Rear Config.	24	
Channel Depth or Max. Placement (in.)	10.5, 16.25, 24, 30, 36	6, 10.5, 12, 16.25	24-36	24, 29, 32, 36	3	Footprint Depth, Front Only Config.	12	
Weight Capacity (lbs.)	2500	2500	2500	1500	1500	Airflow Options	Use in conjunction with airflow baffles	
Flexible Mounting Profile	Integrated feature	Integrated feature	Integrated feature	N/A	N/A	Construction	- Metal channel - Plastic fingers - Metal dual hinged front door (second door is optional in FR)	
19" Mounting Rails	- 19 and 23" mounting in a single platform - #12-24 or 3/8" sq. (M6) - RMU markings - Square hole pattern to accept "D" rings	- 19 and 23" mounting in a single platform - #12-24 or 3/8" sq. (M6) - RMU markings - Square hole pattern to accept "D" rings	- 19 and 23" mounting in a single platform - #12-24 or 3/8" sq. (M6) - RMU markings - Square hole pattern to accept "D" rings - Accepts optional mid-rail kit	- 19" mounting - #12-24 or 3/8" sq. (M6) - RMU markings	- 19" or 23" mounting - #12-24 - RMU markings	Cable Management Features	- Repositionable cable slack spools included (not included with 6" channel) - Obround pattern for cinch straps - Large openings for cable routing	
Cable Management Options	- Circle web serves as lacing points - ¼ "D" rings front, side, and rear of channel - Top waterfall brackets - Finger rail kits - Vertical cable managers - Horizontal cable organizers, 19"	- ¼ "D" rings on front and rear of channel - Top waterfall brackets - Finger rail kits - Vertical cable managers - Horizontal cable organizers, 19"	- ¼ "D" rings on front and rear of channel - Top waterfall brackets - Finger rail kits - Vertical cable managers - Horizontal cable organizers, 19"	- Vertical cable managers - Horizontal cable organizers, 19"	- Vertical cable managers - Horizontal cable organizers, 19"	Cable Fill	See pages 94-95	
Airflow Options	Use with full-height baffles	Use with full-height baffles	Use with full-height baffles	N/A	N/A	Power Options	Button mount pattern along channel for PDUs	
Power Options	Optional PDU bracket and PDU bar for industry PDUs	Optional PDU bracket and PDU bar for industry PDUs	Optional PDU bracket and PDU bar for industry PDUs	PSBGLRR bracket for Great Lakes vertical power strips	PSBGLRR bracket for Great Lakes vertical power strips	Color	Black, Winter White	
Color	Black, Winter White	Black, Winter White	Black, Winter White	Black	Black, Silver	Rack Compatibility	All Great Lakes racks	
Standards	UL2416, RoHS II	UL2416, RoHS II	UL2416, RoHS II	UL2416, RoHS II	UL2416, RoHS II			

CMRX

EXCEPTIONAL CABLE MANAGEMENT SUPPORT IN A SINGLE RACK

- #12-24 tapped channels (with RMU markings) for 19" and 23" mounting
- For 3/8" sq. (M6) channels, add **'M6'** to end of part number
- Cable management pattern of 2.75" circles on 3.25" staggered centers allows for unlimited cable attachment points; square hole pattern between centers accept ¼ turn "D" rings; 20 rings included, 3.5" x 5"
- Square hole pattern and FMP pattern along the front and rear face of channels accept "D" rings and fingers for horizontal cable support
- Four top waterfall brackets with 3" bend radius; two fixed, two adjustable
- Cable runway or basket tray can rest directly on top of the rack or can be supported by optional ladder rack brackets
- Self squaring assembly with toe-in or toe-out orientation (Overall depth listed below is with toe-out footprint)
- Color: Black, Winter White
- Standards: UL2416, RoHS II



Part No.	RMU	H"	W" (19" EIA)	W" (23" EIA)	Channel Depth"	Overall Depth"	Rail Rating lbs.
CMRX-45U10	45	84	24	28	10.5	14.1	2500
CMRX-45U16	45	84	24	28	16.25	19.85	2500
CMRX-45U24	45	84	24	28	24	27.6	2500
CMRX-45U30	45	84	24	28	30	33.6	2500
CMRX-45U36	45	84	24	28	36	39.6	2500
CMRX-52U10	52	96.25	24	28	10.5	14.1	2500
CMRX-52U16	52	96.25	24	28	16.25	19.85	2500
CMRX-52U24	52	96.25	24	28	24	27.6	2500
CMRX-52U30	52	96.25	24	28	30	33.6	2500
CMRX-52U36	52	96.25	24	28	36	39.6	2500
CMRX-59U10	59	108.5	24	28	10.5	14.1	2500
CMRX-59U16	59	108.5	24	28	16.25	19.85	2500
CMRX-59U24	59	108.5	24	28	24	27.6	2500
CMRX-59U30	59	108.5	24	28	30	33.6	2500
CMRX-59U36	59	108.5	24	28	36	39.6	2500

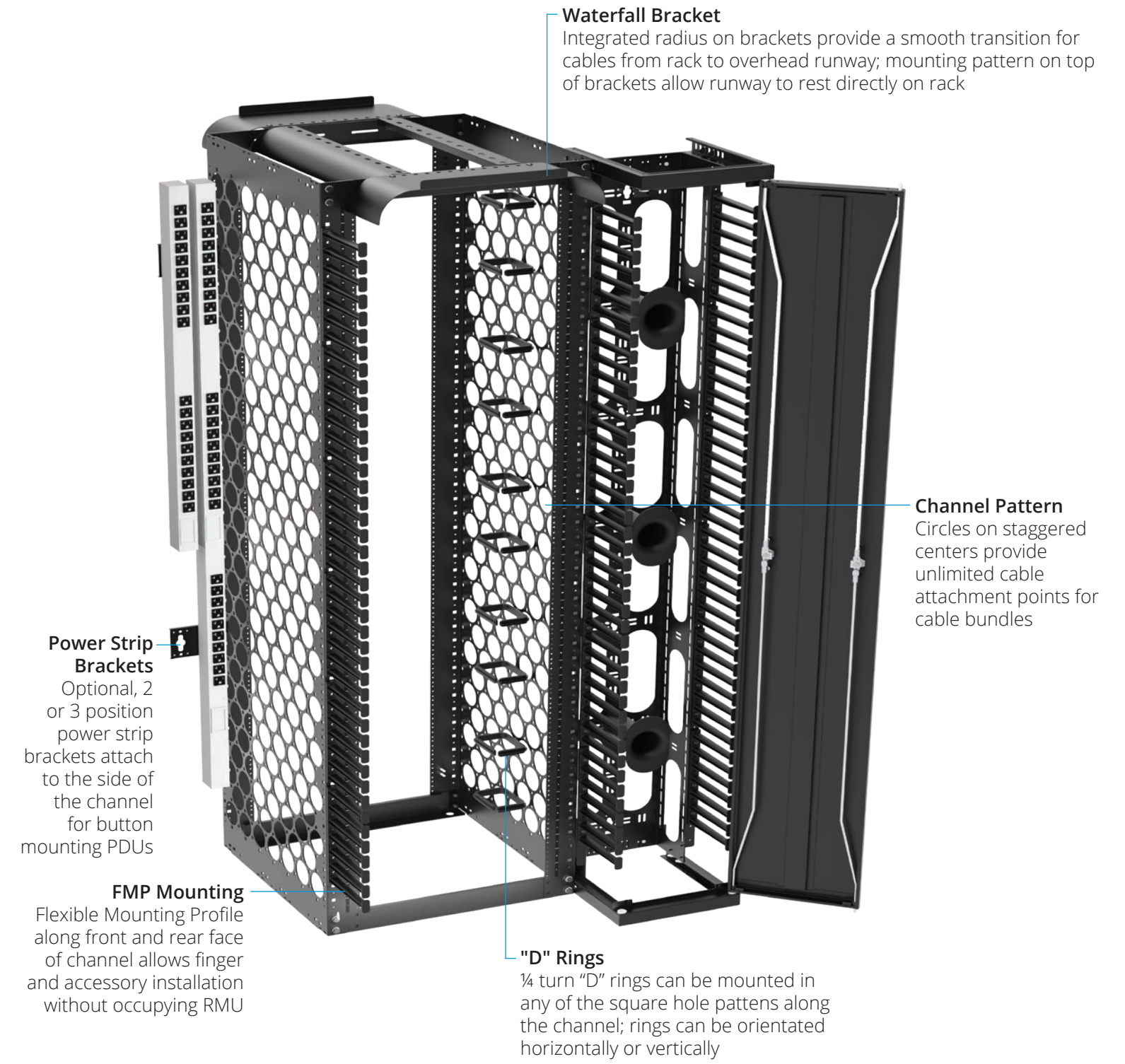

Waterfall Bracket
Integrated radius on brackets provide a smooth transition for cables from rack to overhead runway; mounting pattern on top of brackets allow runway to rest directly on rack

Channel Pattern
Circles on staggered centers provide unlimited cable attachment points for cable bundles

Power Strip Brackets
Optional, 2 or 3 position power strip brackets attach to the side of the channel for button mounting PDUs

FMP Mounting
Flexible Mounting Profile along front and rear face of channel allows finger and accessory installation without occupying RMU

"D" Rings
¼ turn "D" rings can be mounted in any of the square hole patterns along the channel; rings can be orientated horizontally or vertically

CMR

OPEN CHANNEL DESIGN FOR EASY CABLE INSTALLATION & ROUTING

- #12-24 tapped channels (with RMU markings) for 19" and 23" mounting
- For 3/8" sq. (M6) channels, add **'M6'** to end of part number
- Square hole and FMP pattern along the front and rear face of channels accept ¼ turn "D" rings (20 rings included, 3.5" x 5") and fingers for horizontal cable support
- Large channel openings support side-to-side airflow and allow cable pass-thru
- Four top waterfall brackets with 3" bend radius; two fixed, two adjustable
- Cable runway or basket tray can rest directly on top of the rack or can be supported by optional ladder rack brackets
- Self squaring assembly with toe-in or toe-out orientation (Overall depth listed below is with toe-out footprint)
- Color: Black, Winter White
- Standards: UL2416, RoHS II

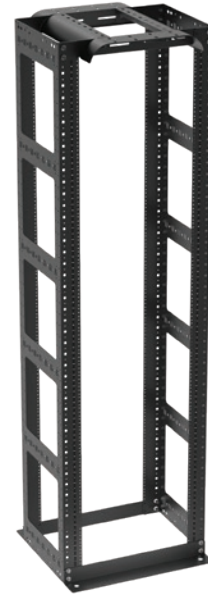

Part No.	RMU	H"	W" (19" EIA)	W" (23" EIA)	Channel Depth"	Overall Depth"	Rail Rating lbs.
CMR-45U6	45	84	24	28	6	12.5	2500
CMR-45U10	45	84	24	28	10.5	17	2500
CMR-45U12	45	84	24	28	12	18.5	2500
CMR-45U16	45	84	24	28	16.25	22.75	2500
CMR-52U6	52	96.25	24	28	6	12.5	2500
CMR-52U10	52	96.25	24	28	10.5	17	2500
CMR-52U12	52	96.25	24	28	12	18.5	2500
CMR-52U16	52	96.25	24	28	16.25	22.75	2500
CMR-59U6	59	108.5	24	28	6	12.5	2500
CMR-59U10	59	108.5	24	28	10.5	17	2500
CMR-59U12	59	108.5	24	28	12	18.5	2500
CMR-59U16	59	108.5	24	28	16.25	22.75	2500

"D" Ring Mounting
¼ turn "D" rings can be mounted in any of the square hole patterns along the channel; rings can be orientated horizontally or vertically

Waterfall Brackets
Integrated radius on brackets provide a smooth transition for cables from rack to overhead runway; mounting pattern on top of brackets allow runway to rest directly on top of rack

Channel Openings
Large openings provide space for cable maintenance/installation and easy cable pass-thru for routing cable inside or outside of the channel

FMP Mounting
Flexible Mounting Profile along front and rear face of channel allows finger (optional) and accessory installation without occupying RMU

Assembly and Mounting
Self-squaring assembly with options for 19 or 23" EIA mounting (no additional hardware required!)

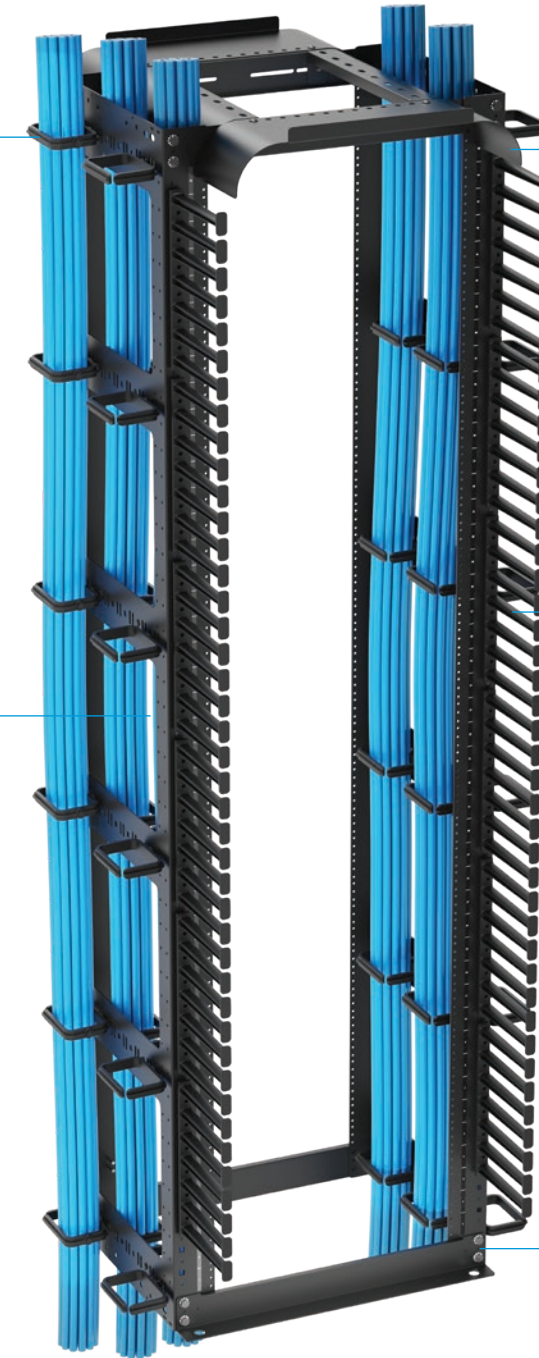

VRX VARIABLE DEPTH

ADJUSTABLE AND ADAPTABLE FOR UNIVERSAL DEPLOYMENT

- #12-24 tapped channels (with RMU markings) for 19" and 23" mounting
- For 3/8" sq. (M6) channels, add **'M6'** to end of part number
- Square hole and FMP pattern along the front face of all rails except "D" rings and fingers for horizontal cable support
- FMP pattern along the side and rear face of all rails accept additional cable management accessories and PDU mounting options
- Side rails provide variable depth in 1" increments
- Self squaring assembly with toe-in or toe-out orientation (Overall depth listed below is with toe-out footprint)
- Color: Black, Winter White
- Standards: UL2416, RoHS II



Part No.	RMU	H"	W" (19" EIA)	W" (23" EIA)	Channel Depth"	Overall Depth"	Rail Rating lbs.
VRX-45U2436	45	84	24	28	24-36	27.6-39.6	2500
VRX-52U2436	52	96.25	24	28	24-36	27.6-39.6	2500
VRX-59U2436	59	108.5	24	28	24-36	27.6-39.6	2500

Part No.	Description
----------	-------------

CABLE MANAGEMENT OPTIONS

VRX-CMU	Cable management upgrade kit, includes front and rear top waterfall trough, depth waterfall brackets, 7"D cable management fingers (qty. 20), ¼ turn "D" rings, 3.5" x 5" (qty. 20)
VRXK1-XXU	Mid-rail kit with #12-24 mounting (when ordering, specify RMU)
VRXKM6-XXU	Mid-rail kit with 3/8" sq. (M6) mounting (when ordering, specify RMU)

PDU/Cable Management Bar
The VPCB1 mounts to the side of the channel in a PDU (to button mount a single PDU) or cable management orientation (to provide additional mounting points for fingers and "D" rings)

Overhead Mounting
Mounting pattern on top of rack allows runway to rest directly on rack or accepts ladder rack brackets

"D" Ring Mounting
¼ turn "D" rings (optional) can be mounted in any of the square hole patterns along the channel; rings can be orientated horizontally or vertically

FMP Mounting
Flexible Mounting Profile along front and rear face of channel allows finger (optional) and accessory installation without occupying RMU

Variable Depth
Side rails provide variable depth in 1" increments

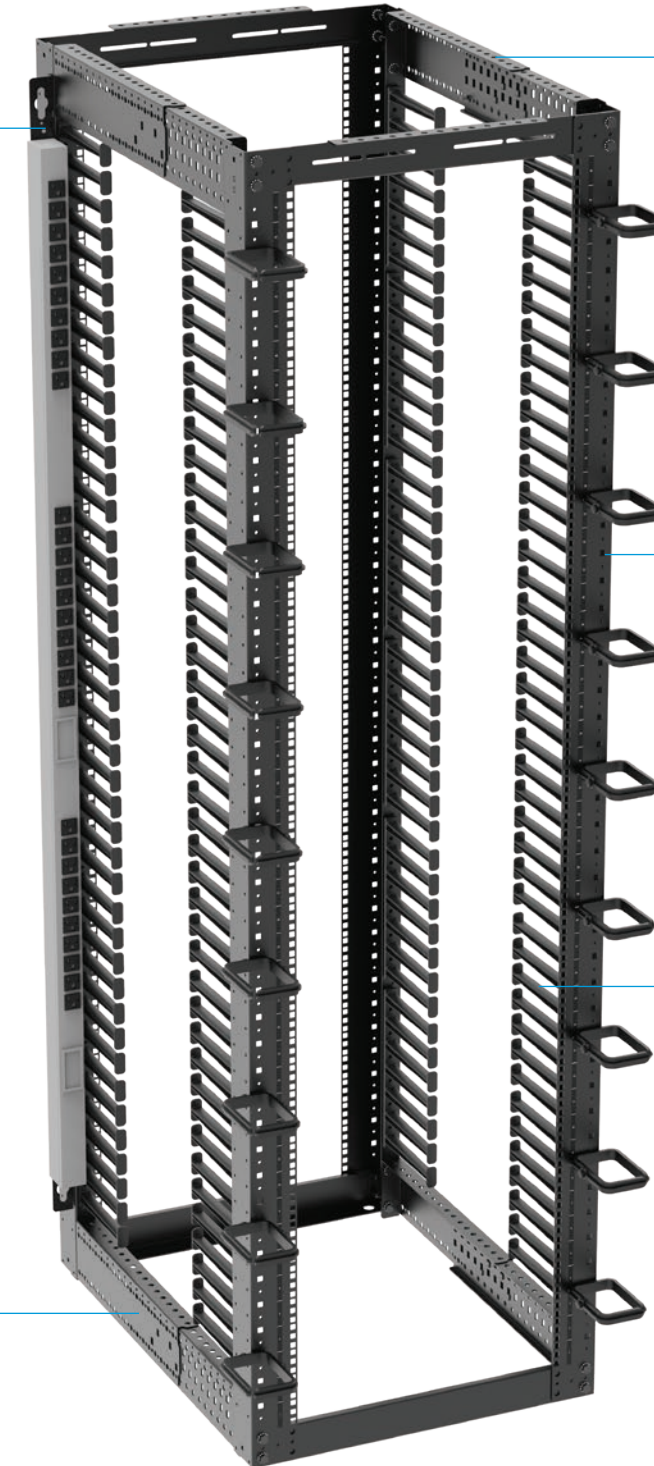

4P FIXED DEPTH

EFFORTLESS RACK FOR SERVER APPLICATIONS

- #12-24 tapped channels (with RMU markings) for 19" mounting
 - For 84"H racks with 3/8 sq. M6 mounting, add **'M6'** to end of part number
 - 96.25" and 108.5"H racks available with #12-24 mounting only
- Overall depth listed below is with toe-out footprint
- Color: Black
- Standards: UL2416, RoHS II

Part No.	RMU	H"	W"	Channel Depth"	Overall Depth"	Rail Rating lbs.
4P-45U24	45	84	20	24	36	1500
4P-45U29	45	84	20	29	41	1500
4P-45U32	45	84	20	32	44	1500
4P-45U36	45	84	20	36	48	1500
4P-45U42	45	84	20	42	54	1500
4P-52U24	52	96.25	20	24	36	1500
4P-52U29	52	96.25	20	29	41	1500
4P-52U32	52	96.25	20	32	44	1500
4P-52U36	52	96.25	20	36	48	1500
4P-52U42	52	96.25	20	42	54	1500
4P-59U24	59	108.5	20	24	36	1500
4P-59U29	59	108.5	20	29	41	1500
4P-59U32	59	108.5	20	32	44	1500
4P-59U36	59	108.5	20	36	48	1500
4P-59U42	59	108.5	20	42	54	1500

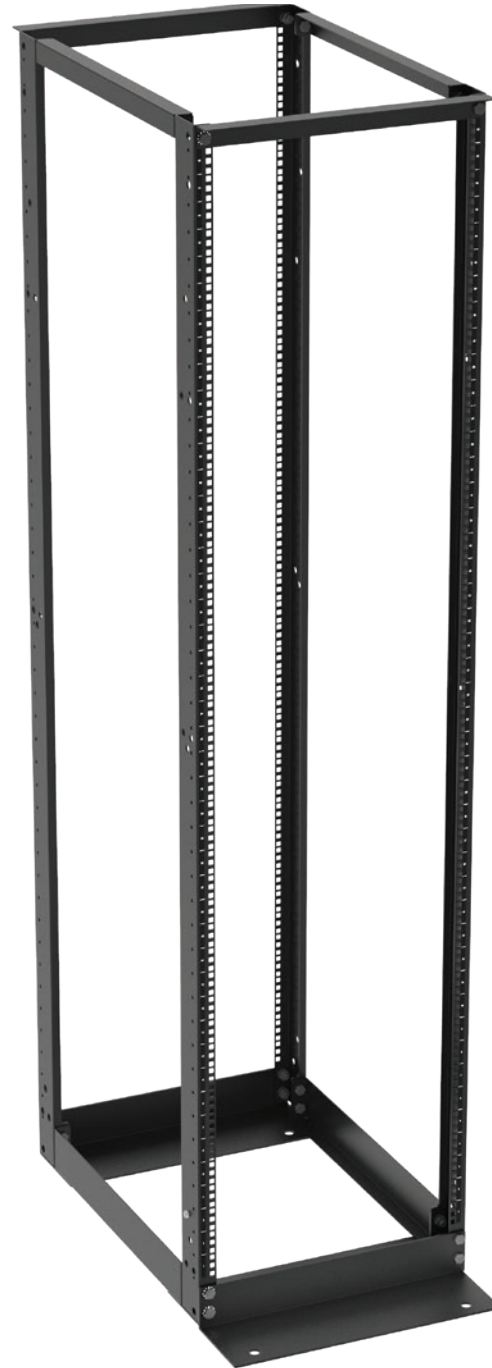

TWO POST

EFFORTLESS RACK FOR NETWORK APPLICATIONS

- #12-24 tapped channels (with RMU markings) for 19" or 23" mounting
- Overall depth listed below is with toe-out footprint
- Color: Black (anodized finish), silver (mill finish)
- Standards: UL2416, RoHS II

Part No.	RMU	H"	W"	Channel Depth"	Overall Depth"	Rail Rating lbs.
Racks with 19" EIA						
GLRR-1948BA	24	48	20	3	14	1500
GLRR-1960BA	31	60	20	3	14	1500
GLRR-1966BA	35	66	20	3	14	1500
GLRR-1972BA	38	72	20	3	14	1500
GLRR-1984BA	45	84	20	3	14	1500
GLRR-1996BA	52	96	20	3	14	1500
GLRR-19108BA	59	108	20	3	14	1500
Racks with 23" EIA						
GLRR-2348BA	24	48	24	3	14	1500
GLRR-2360BA	31	60	24	3	14	1500
GLRR-2366BA	35	66	24	3	14	1500
GLRR-2372BA	38	72	24	3	14	1500
GLRR-2384BA	45	84	24	3	14	1500
GLRR-2396BA	52	96	24	3	14	1500
GLRR-23108BA	59	108	24	3	14	1500

For silver mill finish rack, remove 'BA' from part number

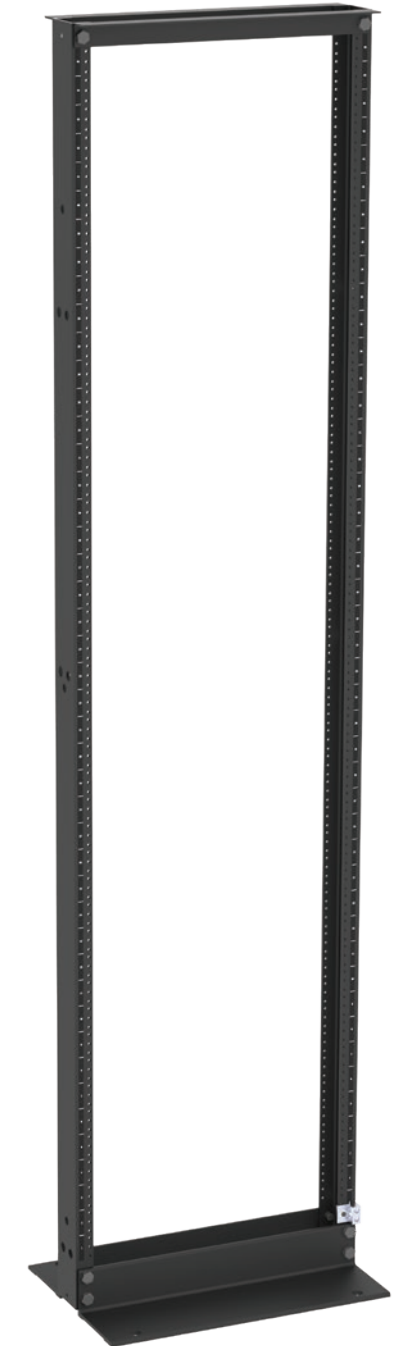

VCM-FO

FULLY ASSEMBLED AND READY TO ACCOMPANY ANY RACK

- Front only configuration, ships assembled
- Self-supporting VCM rests on the floor for improved stability and easy installation
- Metal channel with plastic fingers
- Metal dual hinged front door for left-hand or right-hand opening
- Obround pattern along channel for cinch straps
- Keyhole pattern in multiple vertical locations along channel for button mounting PDUs
- Repositionable cable slack spools included with 8, 10, and 12" configurations
- Mounting holes allow VCM to mount flush with racks or at a varied depth
- Color: Black, Winter White



Part No.	RMU	H"	W"	D"	Channel Config.	Cable Fill
VCM-45U-612FO	45	84	6	12	Front Only	41
VCM-45U-812FO	45	84	8	12	Front Only	62
VCM-45U-1012FO	45	84	10	12	Front Only	82
VCMX-45U-1012FO	45	84	10*	12	Front Only	82
VCM-45U-1212FO	45	84	12	12	Front Only	103
VCM-52U-612FO	52	96.25	6	12	Front Only	41
VCM-52U-812FO	52	96.25	8	12	Front Only	62
VCM-52U-1012FO	52	96.25	10	12	Front Only	82
VCMX-52U-1012FO	52	96.25	10*	12	Front Only	82
VCM-52U-1212FO	52	96.25	12	12	Front Only	103
VCM-59U-612FO	59	108.5	6	12	Front Only	41
VCM-59U-812FO	59	108.5	8	12	Front Only	62
VCM-59U-1012FO	59	108.5	10	12	Front Only	82
VCMX-59U-1012FO	59	108.5	10*	12	Front Only	82
VCM-59U-1212FO	59	108.5	12	12	Front Only	103

Note: 50% cable fill determined with CAT 6A cables with 0.3 outside diameter.
* Manager is recessed when ganged with racks, 6" spacing.

VCM-FR

FULLY ASSEMBLED AND READY TO ACCOMPANY ANY RACK

- Front and rear configuration ships assembled
- Self-supporting VCM rests on the floor for improved stability and easy installation
- Metal channel with plastic fingers
- Metal dual hinged front door for left-hand or right-hand opening
- Metal single hinged rear door, field reversible
- Obround pattern along channel for cinch straps
- Repositionable cable slack spools included with 8, 10, and 12" configurations
- Mounting holes allow VCM to mount flush with racks or at a varied depth
- Color: Black, Winter White

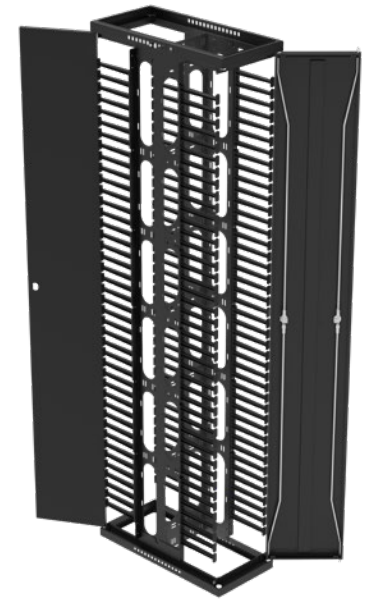

Part No.	RMU	H"	W"	D"	Channel Config.	Cable Fill
VCM-45U-612FR	45	84	6	24	Front and Rear	85
VCM-45U-812FR	45	84	8	24	Front and Rear	125
VCM-45U-1012FR	45	84	10	24	Front and Rear	164
VCM-45U-1212FR	45	84	12	24	Front and Rear	204
VCM-52U-612FR	52	96.25	6	24	Front and Rear	85
VCM-52U-812FR	52	96.25	8	24	Front and Rear	125
VCM-52U-1012FR	52	96.25	10	24	Front and Rear	164
VCM-52U-1212FR	52	96.25	12	24	Front and Rear	204
VCM-59U-612FR	59	108.5	6	24	Front and Rear	85
VCM-59U-812FR	59	108.5	8	24	Front and Rear	125
VCM-59U-1012FR	59	108.5	10	24	Front and Rear	164
VCM-59U-1212FR	59	108.5	12	24	Front and Rear	204

Note: 50% cable fill determined with CAT 6A cables with 0.3 outside diameter.

RACK ACCESSORIES

Part No.	Description	Compatible Rack
----------	-------------	-----------------

VERTICAL CABLE MANAGERS, PLASTIC

Plastic vertical cable managers in front only or front and rear configuration; color: black

VCMP-55FO	Front only, 5" x 5"; includes snap-on cover	84"H Racks
VCMP-55FR	Front and rear, 5" x 5"; includes snap-on covers	84"H Racks
VCMP-88FO	Front only, 8" x 8"; includes 2 spools, 6 wire retainers, and hinged cover	84"H Racks
VCMP-88FR	Front and rear, 8" x 8"; includes 2 spools, 12 wire retainers, and hinged covers	84"H Racks

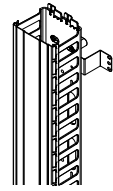

VCMP-55FO

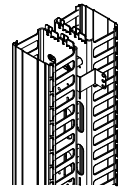

VCMP-55FR

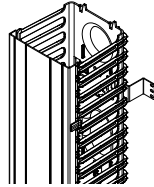

VCMP-88FO

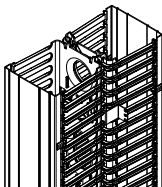

VCMP-88FR

Part No.	Description	Compatible Rack
----------	-------------	-----------------

OVERHEAD SUPPORT BRACKETS

Part number consists of a single bracket to support cable runway and basket tray

LRBV4-8	Bracket with 3" waterfall bend radius; configure LRB to 4, 6, and 8" height; supports 12-24"W ladder	CMRX, CMR, VRX
1984LR	Flat bracket, mounts perpendicular or parallel; supports 12-18"W ladder	4P, GLRR (2P)

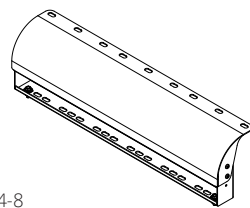

LRBV4-8

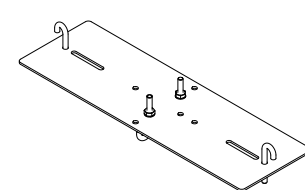

1984LR

Part No.	Description	Compatible Rack
----------	-------------	-----------------

FINGERS & RINGS

Accessories mount along the FMP uprights; fingers available in black plastic

CM-47	4" X 7 RMU, single finger section	CMRX, CMR, VRX
ESC-K12	4" x 7 RMU, set of 12 finger sections	CMRX, CMR, VRX
CM-77	7" X 7 RMU, single finger section	CMRX, CMR, VRX
ESC-K12-7	7" x 7 RMU, set of 12 finger sections	CMRX, CMR, VRX
CM-11	3"W x 5"D, set of five rings	CMRX, CMR, VRX

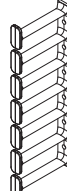

CM-47

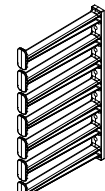

CM-77

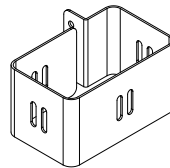

CM-11

Part No.	Description	Compatible Rack
----------	-------------	-----------------

ZERO-U MOUNTING BRACKETS

Set of two brackets mount along the FMP of E rails to vertically mount 19" equipment such as patch panels and horizontal cable organizers

ZR2	Mounts 2 RMU of equipment	CMRX, CMR, VRX
ZR1	Mounts 1 RMU of equipment	CMRX, CMR, VRX

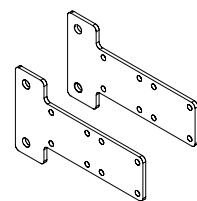

ZR2

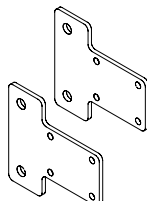

ZR1

RACK ACCESSORIES

Part No.	Description	Compatible Rack
----------	-------------	-----------------

POWER STRIP BRACKETS

Pair of brackets with mounting positions to button mount PDUs and basic power strips

PDU3ER	One pair of brackets with 3 mounting positions for PDUs	CMRX, CMR, VRX
PDU2ER	One pair of brackets with 2 mounting positions for PDUs	CMRX, CMR, VRX
PSBGLRR	One pair of brackets, mounts a single vertical basic power strip	4P, GLRR (2P)

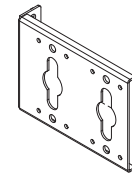

PDU2ER

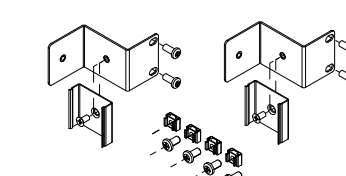
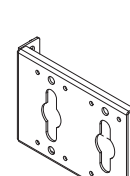

PSBGLRR

Part No.	Description	Compatible Rack
----------	-------------	-----------------

VERTICAL POWER CABLE BAR

"L" shaped bar for use in cable management (add ¼ "D" rings) or PDU orientation

VPCB1	Single power cable bar	CMRX, CMR, VRX
-------	------------------------	----------------

Part No.	Description	Compatible Rack
----------	-------------	-----------------

CINCH STRAPS

Use with parts that feature obround pattern or on stand-alone cable bundles

CM-01	3/4"W x 12"L, single blue strap	N/A
CM-06	3/4"W x 6"L, single black strap	N/A

Part No.	Description	Compatible Rack
----------	-------------	-----------------

SIDE AIRFLOW BAFFLES

Full height baffles direct cool air in and exhaust air away when used with side-to-side airflow equipment; knockouts with brush grommet allow cable pass-thru

4PBK2436	Adjustable baffle, 24-36"	CMRX, CMR, VRX
4PBK1624	Adjustable baffle, 16-24"	CMRX, CMR, VRX
4PBK12	Fixed baffle, 12"	CMRX, CMR, VRX

Part No.	Description	Compatible Rack
----------	-------------	-----------------

1/4 TURN "D" RINGS

Plastic rings to mount in square hole pattern along rack channels and VPCB1

CM-25	1.5" x 3.5", set of 10 rings	CMRX, CMR, VRX, UCR
CM-26	3.5" x 5", set of 10 rings	CMRX, CMR, VRX, UCR

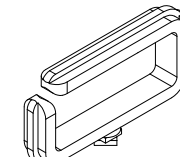

CM-25

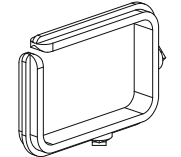

CM-26

Part No.	Description	Compatible Rack
----------	-------------	-----------------

VARIABLE SPACER GANGING KITS

Facilitate proper spacing between racks so vertical cable managers and baffle kits can be added; brackets adjust in 1-inch increments

VSBK68	Adjusts from 6-8"	CMRX, CMR, VRX
VSBK914	Adjusts from 9-14"	CMRX, CMR, VRX

Part No.	Description	Compatible Rack
----------	-------------	-----------------

ADDITIONAL ITEMS

HDW-104-50	#12-24 x ½" screws, package of 50	N/A
HDW-107-50	Cage nuts with #12-24 x ½" screws, package of 50	N/A
AK101	Anchor kit, four torque controlled anchors to bolt rack to floor	All racks
GL-RMUTA	Package of four RMU labels in ascending order (1 on bottom)	All racks
GL-RMUTD	Package of four RMU labels in descending order (1 on top)	All racks

CABLE RUNWAY RACK

INCREASE RMU SPACE BY GOING ABOVE & BEYOND THE RACK

- #12-24 tapped channels for 19" mounting
- Hang and secure from Great Lakes Universal Cable Runway or overhead infrastructure products, including basket tray
- Square hole pattern along front, rear, and side face of channels to accept optional ¼ turn "D" rings
- Color: Black, Winter White

Part No.	RMU	H"	W"	Channel Depth"
UCR-HRS-2U4	2	5.4	21	4
UCR-HRS-4U4	4	8.9	21	4
UCR-HRS-6U4	6	12.4	21	4

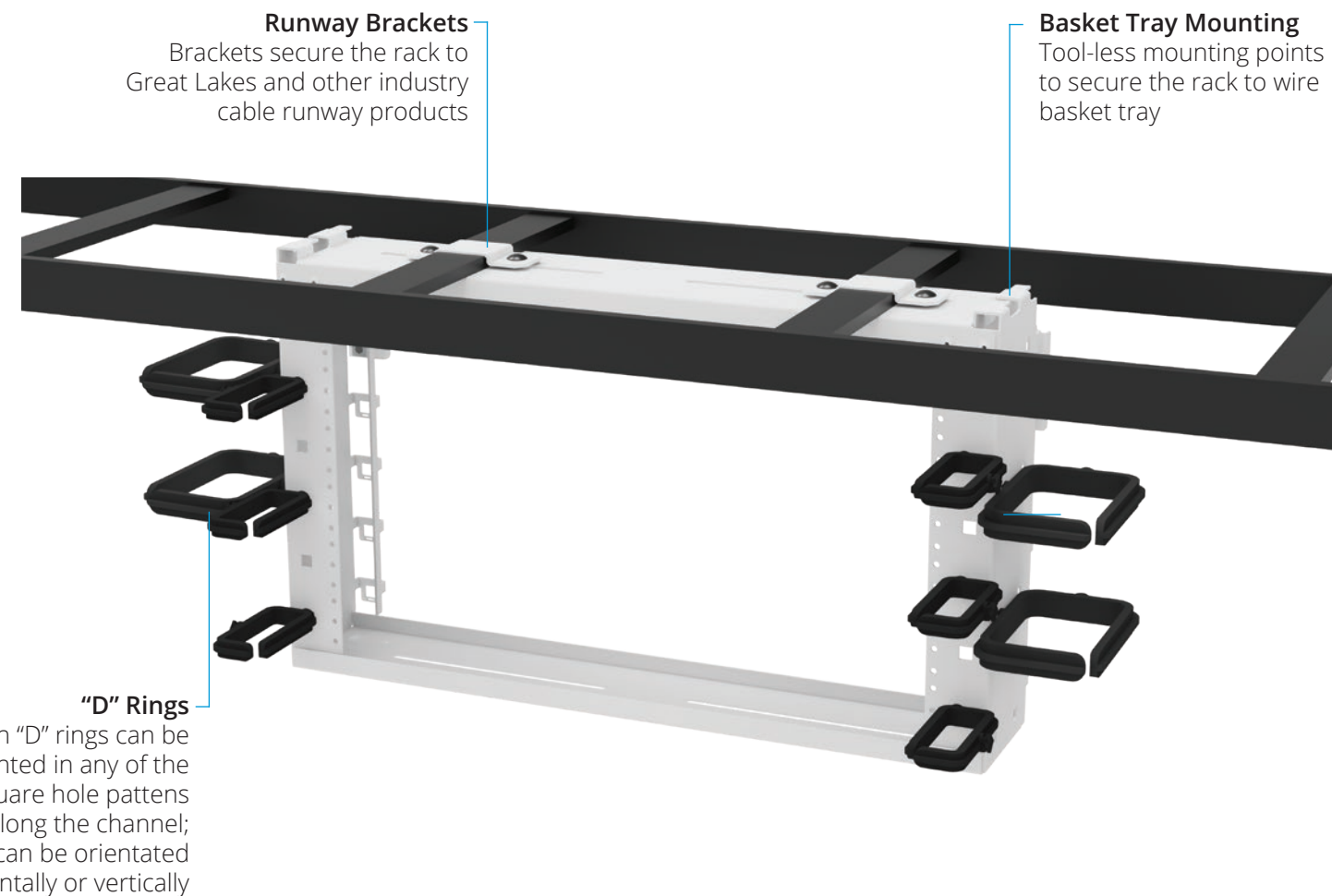

SECURITY PANEL SYSTEM

We rack your world.

PROTECT THE PERIMETER.

Sensitive equipment. Colocation centers. Security and privacy requirements. All of these pose challenges. But nothing our security panel system can't handle.

How do we do it? With secure panels and posts that prevent access to assembly hardware. Simple modular design that makes assembly a breeze. Even options to create 360 degrees of protection or meet fire code and ADA requirements.

You can mix and match your security levels, your access controls, your panel materials...heck, even your colors. It's all in stock and ready for you to configure.

Just another way we rack your world.

"Your security needs can change rapidly. So can our security panel system."

Paul Senger - Engineer



GreatCabinets.com

SECURITY PANEL SYSTEM



STRATEGIC DEPLOYMENT INTERNAL INFRASTRUCTURE SOLUTIONS

CUSTOMER SEPARATION

Tenant space in this colocation facility is separated to ensure cabinets and equipment remain secure within the shared data center. An intelligent handle provides the tenant with a system to monitor and manage who has access to the space—especially useful when the tenant does not visit the colo facility regularly.

MECHANICAL INFRASTRUCTURE

Power distribution units deployed on the data center floor of a colocation facility are isolated from cabinets—as recommended by BICSI in top-tier hosting facilities. PDUs, CRAC units and other mechanical infrastructure that are imperative to uptime are safeguarded from tenants and can only be accessed by authorized employees of the colo facility.

EXPANDABLE IDF CLOSET

A dedicated telecommunications closet is built on the open warehouse floor which proved to be the best location for the intermediate distribution frame (IDF) at this facility. The modular build-out of the system will allow the size of the closet to grow as the IDF grows with the expansion of the facility.

EQUIPMENT SEGREGATION

Storage and network equipment, managed by different individuals at this Fortune 100 company, are separated by a custom (in color and material) security panel system. The company's risk management team require the separation so that ownership and responsibility for uptime (and even downtime) can be appropriately managed.



SEAL Perimeter layer protection around equipment where it is needed the most!

SECURITY PANEL SYSTEM

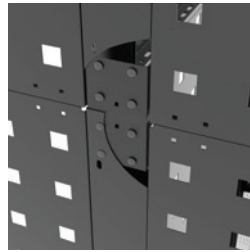

Secured Hardware

Panel-to-post assembly hardware is secured inside of the room and is concealed with a riveted cover panel to prevent tampering

SEAL Electronic Access

Optional intelligent access control to monitor and manage entry; compatible with sliding and swinging doors



Simple Assembly

Modular system—build out a room in as little as five part numbers

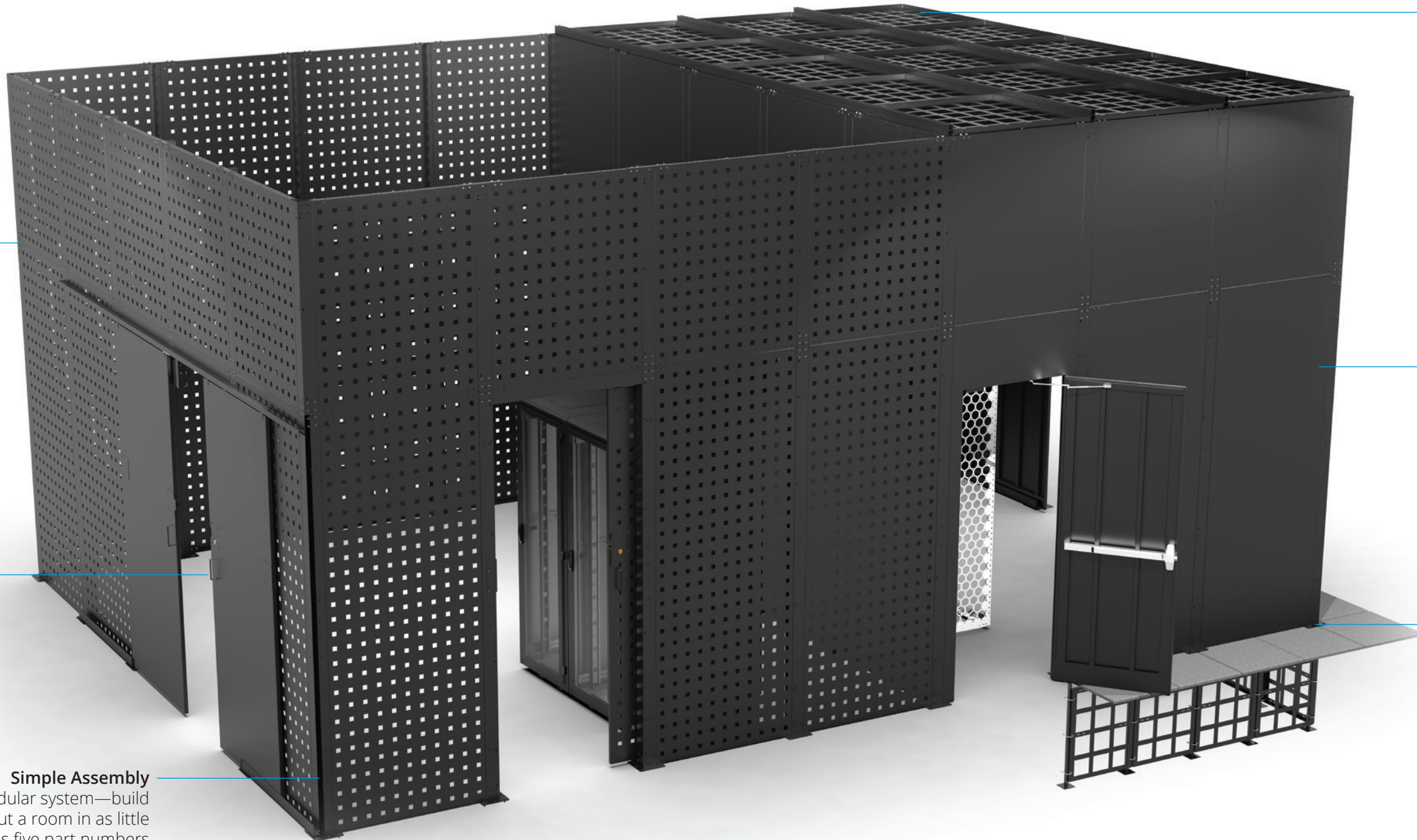

Custom Options

Overhead and underfloor custom solutions create 360° of protection; additional variations include material, construction, and color

Construction

Aluminum panels and steel posts provide a physical deterrent to protect against bending, cutting, and intentional damage

Self-Supporting

Strong materials and design mean it's not necessary to attach systems to a wall or ceiling for stability; proper post and panel installation fully support the system

POST AND PANELS

BASE POST

114"H - Includes top support bracket and post cover (riveted cover so assembly hardware is not exposed); Steel

SP114-BPST Single post

UPPER POST

54"H - Includes post cover (riveted cover so assembly hardware is not exposed); Steel

SP54-UPST Single post

BASE PANELS

114"H, Aluminum

SP114-BP-48V Vented, 48"W

SP114-BP-48S Solid, 48"W

SP114-BP-24V Vented, 24"W

SP114-BP-24S Solid, 24"W

SP114-BP-12V Vented, 12"W

SP114-BP-12S Solid, 12"W

UPPER PANELS

54"H, Aluminum

SP54-UP-48V Vented, 48"W

SP54-UP-48S Solid, 48"W

SP54-UP-24V Vented, 24"W

SP54-UP-24S Solid, 24"W

SP54-UP-12V Vented, 12"W

SP54-UP-12S Solid, 12"W

ADJUSTABLE BASE PANELS

114"H - Installs from post-to-post or from post-to-wall, Aluminum

SP114-ABP-35S Solid, 3-5"

SP114-ABP-812S Solid, 8-12"

SP114-ABP-1118S Solid, 11-18"

SP114-ABP-1724S Solid, 17-24"

ADJUSTABLE UPPER PANELS

54"H - Installs from post-to-post or from post-to-wall, Aluminum

SP54-AUP-35S Solid, 3-5"

SP54-AUP-812S Solid, 8-12"

SP54-AUP-1118S Solid, 11-18"

SP54-AUP-1724S Solid, 17-24"

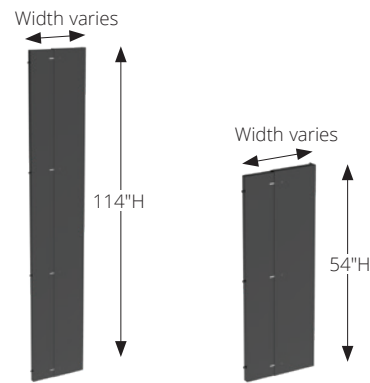
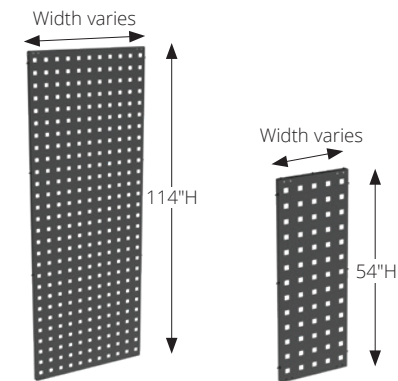
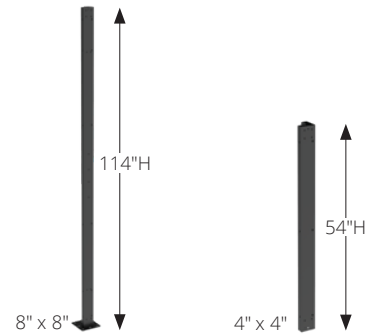

DOORS

SLIDING DOORS

114"H x 48"W doors, Aluminum

SP114-SLDR-48V Vented with pull handle and keyed gate lock, manual close

SP114-SLDR-48S Solid with pull handle and keyed gate lock, manual close

SP114-SLDR-48VAC Vented with pull handle and keyed gate lock, auto close

SP114-SLDR-48SAC Solid with pull handle and keyed gate lock, auto close



Sliding

DOUBLE SLIDING DOORS

114"H x 96"W doors, Aluminum

SP114-DSLDR-96V Vented with pull handle and keyed gate lock, manual close

SP114-DSLDR-96S Solid with pull handle and keyed gate lock, manual close

SP114-DSLDR-96VAC Vented with pull handle and keyed gate lock, auto close

SP114-DSLDR-96SAC Solid with pull handle and keyed gate lock, auto close

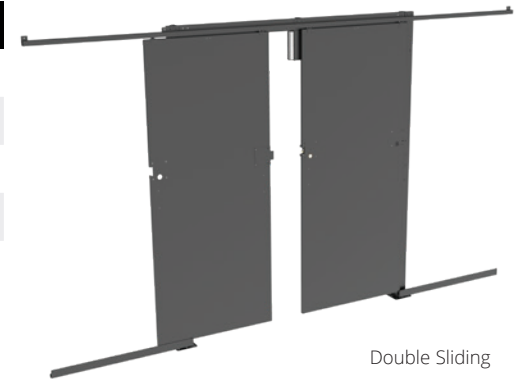

Double Sliding

EGRESS SWINGING DOORS

114"H x 48"W doors, Aluminum

SP114-SWDR-LH48S Solid, swings to the left; emergency exit with auto close; door can be upgraded to serve as an entrance by adding electronic door access and an electronic strike

SP114-SWDR-RH48S Solid, swings to the right; emergency exit with auto close; door can be upgraded to serve as an entrance by adding electronic door access and an electronic strike



Swinging

ACCESS CONTROL

ELECTRONIC DOOR ACCESS

Intelligent access control limits, monitors, and manages individuals with access into the secure space

GLSPXHSEAL-4045	Pinpad and HID reader, stand-alone system; Single-door proximity access control with quick installation—no user interface required for setup and use
GLASPXSEAL-RP40	HID reader that integrates with existing BMS*; compatible with a growing range of technologies to function with existing BMS access control
GLASPXSEAL-RP40EVO	HID reader, stand-alone system; Simple user interface that uses a standard web browser
GLASPXSEAL-W2	Biometric scanner and card reader that integrates with existing BMS*; Provides increased security measures through finger-print authentication and support of dual-frequency RFID technology

*BMS, Building Management System

ELECTRONIC DOOR LOCKS

An electronic door lock is required when electronic door access will be used

GL-SLDRML-SEAL01	Electromagnetic lock for use on sliding doors
GL-SWDREL-SEAL01	Electronic strike for use on swinging door (allows door to be used as an entrance point)



Pinpad/HID

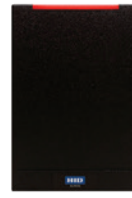

HID, BMS*



HID, Stand Alone



Biometric



Electromagnetic Lock



Electronic Strike

We rack your world.

UP. UP. **AND AWAY.**

All those data cables have to go somewhere. Preferably, out of sight. And most times, down under is not an option.

That's why we're always looking up. At our cable runways.

Sections of every length. To go up and over a continuous row of racks. Short and long runs over cabinets of different heights.

A gradual bend around the outside. An even smoother turn to the inside. Plus, kits and parts that splice, elevate and triangulate as needed.

After all, if we're going to rack your world, we can at least keep it neat and tidy.

“When it comes to cable management, it’s all in the details.”

Brian Franz - Regional Sales Manager



GreatCabinets.com

CABLE RUNWAY

Part No.	Description
----------	-------------

CABLE RUNWAY 10' SECTION

Constructed of rectangular steel tubing; 130 lb/ft max. load with runway supported every five feet; meets ANSI/TIA/EIA guidelines; black (Easy ship option: two 5' sections of runway with butt splice kit, call for details)

GL-CR610	6"W Cable runway, 10' section
GL-CR1210	12"W Cable runway, 10' section
GL-CR1810	18"W Cable runway, 10' section
GL-CR2410	24"W Cable runway, 10' section

Part No.	Description
----------	-------------

CABLE RUNWAY OUTSIDE BEND

Creates a gradual bend for outside bends; black

GL-CR6VB0	6"W Cable runway outside radius bend
GL-CR12VB0	12"W Cable runway outside radius bend
GL-CR18VB0	18"W Cable runway outside radius bend
GL-CR24VB0	24"W Cable runway outside radius bend

Part No.	Description
----------	-------------

END CAP

GL-CR-EC	Pair of cable runway end caps; black plastic
----------	--



Cable Runway 10' Section



Cable Runway 90° Bend



Cable Runway Outside Bend



Cable Runway Inside Bend

Part No.	Description
----------	-------------

CABLE RUNWAY 90° BEND

Creates a gradual bend in the horizontal plane of cable runway; designed for cabling in conformance with the minimum bend radius requirements (typically 4 times the cable diameter); black

GL-CR690	6"W Cable runway 90° bend
GL-CR1290	12"W Cable runway 90° bend
GL-CR1890	18"W Cable runway 90° bend
GL-CR2490	24"W Cable runway 90° bend

Part No.	Description
----------	-------------

CABLE RUNWAY INSIDE BEND

Creates a gradual bend for inside bends; black

GL-CR6VB1	6"W Cable runway inside radius bend
GL-CR12VB1	12"W Cable runway inside radius bend
GL-CR18VB1	18"W Cable runway inside radius bend
GL-CR24VB1	24"W Cable runway inside radius bend

CABLE RUNWAY

Part Number	Description
-------------	-------------

TERMINATION KITS

Rack Termination Kit: Universal Mounting plate for data racks
Wall Termination Kit: Angle bracket to attach runway to the wall

GL-CR-RTR18	Rack termination kit, 6"-18"
GL-CR-RTR24	Rack termination kit, 24"
GL-CR-WTK6	6"W Wall termination kit
GL-CR-WTK12	12"W Wall termination kit
GL-CR-WTK18	18"W Wall termination kit
GL-CR-WTK24	24"W Wall termination kit
GL-CR-WTR12	Wall to rack runway kit; includes 12"W cable runway, 5' section; one 12"W wall termination kit; one rack termination kit; and pair of runway end caps



Rack Termination Kit



Wall Termination Kit



Elevation Kit



Triangular Support Bracket

Part No.	Description
----------	-------------

ELEVATION KIT

Supports cable runway above a continuous row of racks or cabinets of varying heights; can be mounted perpendicular or parallel; kit includes two pairs of brackets and assembly hardware; black

GL-CR-REK23	Elevation kit 2-3"
GL-CR-REK46	Elevation kit 4-6"

Part Number	Description
-------------	-------------

TRIANGULAR SUPPORT BRACKET

Provides wall support for universal cable runway

GL-CR-TSB6	6" Bracket
GL-CR-TSB12	12" Bracket
GL-CR-TSB18	18" Bracket
GL-CR-TSB24	24" Bracket

CABLE RUNWAY

Part No. Description

STRUCTURAL SUPPORT

Hardware to support cable runway throughout the facility

GL-CR-VSB	Cable runway vertical support bracket
GL-CR-VWB	Vertical wall bracket
GL-CR-TCR6	Threaded ceiling rod, 3/8"; 6' threaded
GL-CR-RSB38	Runway support bracket, accepts 3/8" rod
GL-CR-RSB58	Runway support bracket, accepts 5/8" rod

Part Number Description

RADIUS DROP

Provides a smooth transition for cables when exiting the runway; helps maintain proper cable bend radius

GL-CR-RD6	6" Radius drop
GL-CR-RD12	12" Radius drop
GL-CR-RD18	18" Radius drop
GL-CR-RD24	24" Radius drop



Vertical Support Bracket



Threaded Ceiling Rod



Radius Drop

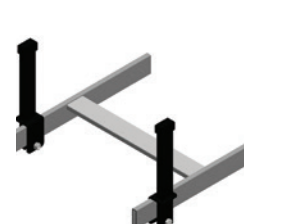

Cable Retaining Post



Vertical Wall Bracket

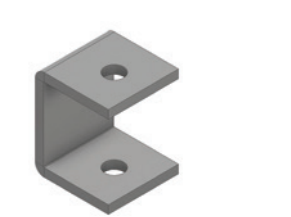

Runway Support Bracket



Corner Bracket



Junction Splice Kit

Part No. Description

CORNER BRACKET

Creates a radius for L, T, or X-shaped intersections of cable runway formed when two or more pieces of cable runway are connected together with the junction splice kit; black

GL-CR-CB24	Corner bracket 24"
------------	--------------------

Part No. Description

CABLE RETAINING POST

Attaches to the outside of the runway to prevent cables from falling off of the runway; black

GL-CR-CRP6	Cable retaining post, 6"
GL-CR-CRP8	Cable retaining post, 8"
GL-CR-CRP10	Cable retaining post, 10"

Part Number Description

SPLICE KITS

Join two sections of runway; zinc plated

GL-CR-JSK	Junction splice kit, join runway to form a perpendicular intersection
GL-CR-BSK	Butt splice kit, join runway end-to-end

We rack your world.

ENGINEERED FOR THE **EXTREME.**

Some data equipment gets to live life in the comfy confines of an air-conditioned office. Not so much in industries like HVAC, oil and gas, water or alt energy.

At Great Lakes, we say, "bring it on."

Whether indoors or outdoors, stuff happens. Like blowing dust. Seeping oil. Falling objects. Freezing snow. And we build industrial data enclosures to handle it all.

How do we do it? With a full-scale, on-site testing lab. Backed by a team of engineers up for any challenge. All in the same facility. So you get what you need when you need it.

We call that racking your world to the extreme.

***"Our industrial cabinets
protect your assets from
intense environments."***

Danilo Bonilla - Regional Sales Manager



GreatCabinets.com

INDUSTRIAL

UNFAVORABLE CLIMATE? KEEP YOUR DATA SAFE.

Indoor and outdoor environments can be unpredictable and damaging to data equipment if your cabinet isn't built to handle unexpected circumstances. Customers are choosing Great Lakes because of our ability to handle the unknown.



ONE OF OUR SUCCESSFUL SOLUTIONS

Over the last 10 years, a telecommunications provider in Mexico has been expanding technology infrastructure across the country. The company was in need of a solution that could accommodate 19 and 21" (not your typical mounting!) EIA equipment while being able to maintain safe operating conditions from not only the weather, but physical human threats.

PRODUCT MANUFACTURED TO THE CUSTOMER'S SPECS:



NEMA 4/IP66

are the standards needed to protect against snow, dust, rainfall, and saltwater. Regions are susceptible to volatile weather due to tropical cyclones, mountainous elevations, and sea level flooding.



12-19K BTU

is the amount of cooling capacity that two air condition units must provide to maintain safe equipment operating temperatures. Units are NEMA rated and provide variable cooling capacity based on outdoor conditions.



SAFE & SECURE

is the requirement needed to prevent physical theft of equipment. Secure locks and a rigid construction prohibit theft of equipment batteries often used for illegal resale and drug production.



ONSITE MANUFACTURING AND TESTING CAPABILITIES TO ENSURE COMPLIANCE AND PROTECTION.

1. Choose a product from Great Lakes portfolio of products: standard cabinets and wall mounts; a vast library of custom designs; or work with our team to create something from scratch.
2. Determine the appropriate IP and NEMA rating that is required for your application.
3. Get in touch with us to place an order or start work on your custom project.

Collaboration with the customer to design and build a product exclusively for their requirements.

LET'S BUILD SOMETHING TOGETHER!

UNIQUE FEATURES — WHAT YOU NEED, WHEN YOU NEED IT.

INDUSTRIAL

STANDARD

Choose from free-standing cabinets and wall mounts available in multiple sizes. Prior to shipping, product can be **configured** with Great Lakes accessories, including 19" cable organizers, filler panels, or shelves.

All cabinets, wall mounts and accessories are stocked and available to **ship in 24-48 hours**. For increased cooling support, IP rated air conditioning units can be ordered.



LIBRARY

Don't see what you want in the catalog, ask us. We've designed and manufactured literally **thousands of industrial designs** over the years – protecting data for customers in the toughest environments.

NEMA 12K, 3R, 4, 4X – pad mount, wall mount, free-standing – you name it – we've probably done it. If we have made something similar to what you are looking for, sometimes all it takes is a tweak to meet your **exact requirements**.

Products can be modified with a specific coating and finish, mounting options, material and construction, and accessories.



CUSTOM

We're also up for a challenge – with a full team of engineers ready to **solve your toughest data protection demands**. We can work together to determine if your product needs increased security—we have IP rated, intelligent access controls.

Need more cooling capacity because cabinets will be deployed near the equator? **No problem.** Already know where conduit knockouts, hole patterns, or additional pems need placed? Let us add the knockouts and pems during the manufacturing process to ensure consistent placement.

We can do all of this to a **design that is uniquely yours**. You dream it up and we'll rack your world.



IP RATING

SOLID OBJECT

- 1** Protected against a solid object greater than 50mm such as a hand
- 2** Protected against a solid object greater than 12.5mm such as a finger
- 3** Protected against a solid object greater than 2.5mm such as a screwdriver
- 4** Protected against a solid object greater than 1mm such as a wire
- 5** Dust protected. Limited ingress of dust permitted. Will not interfere with operation of the equipment
- 6** Dust tight. No ingress of dust.

MOISTURE

- 1** Protected against vertical falling drops of water. Limited ingress permitted.
- 2** Protected against vertical falling drops of water with the cabinet tilted up to 15 degrees from the vertical. Limited ingress permitted.
- 3** Protected against sprays of water up to 60 degrees from the vertical. Limited ingress permitted.
- 4** Protected against water splashes from all directions. Limited ingress permitted.
- 5** Protected against jets of water. Limited ingress permitted.
- 6** Protected against powerful jets of water. Limited ingress permitted.
- 7** Water tight against the effects of immersion in water between 15cm and 1m for 30 minutes.
- 8** Water tight against the effects of immersion in water pressure for long periods.



NEMA RATING

12K

DUST PROTECTION

Constructed (with knockouts) for indoor use to provide a degree of protection to personnel and equipment against

- hazardous parts
- ingress of solid foreign objects (falling dirt and circulating dust, lint, fibers, and flyings)
- ingress of water (dripping and light splashing)

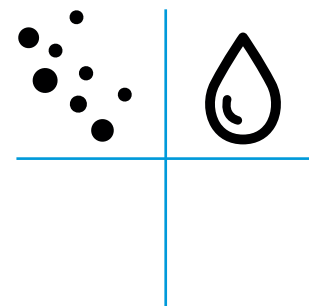

3R

RAIN PROTECTION

Constructed for either indoor or outdoor use to provide a degree of protection to personnel and equipment against

- hazardous parts
- ingress of solid foreign objects (falling dirt)
- ingress of water (rain, sleet, snow)
- formation of ice on the cabinet

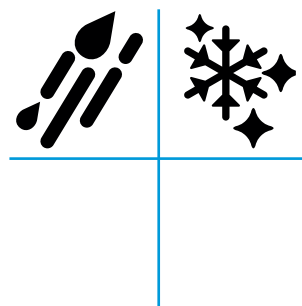

4

WATER PROTECTION

Constructed for either indoor or outdoor use to provide a degree of protection to personnel and equipment against

- hazardous parts
- ingress of solid foreign objects (falling dirt and windblown dust)
- ingress of water (rain, sleet, snow, splashing water, and hose directed water)
- formation of ice on the cabinet

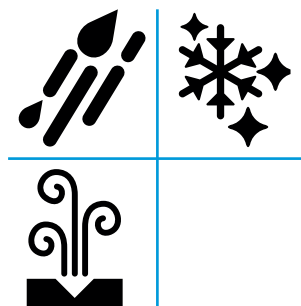

4X

WATER & CORROSION PROTECTION

Constructed for either indoor or outdoor use to provide a degree of protection to personnel and equipment against

- hazardous parts
- ingress of solid foreign objects (falling dirt and windblown dust)
- ingress of water (rain, sleet, snow, splashing water, and hose directed water); that provides an additional level of protection against corrosion
- formation of ice on the cabinet

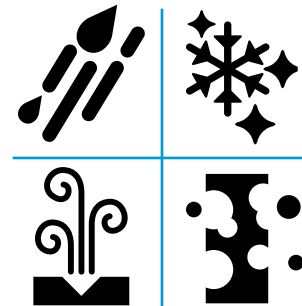

We rack your world.

WE GOT THE **POWER.**

It's no secret. All your sophisticated data equipment draws a lot of power. Typically, that does two things – generate heat and increase costs.

But at Great Lakes, we don't do typical.

We figure if we're building the best data racks, why not make the best power systems to boot. And integrate them into our products. At no additional cost.

Pretty cool, huh? Almost as cool as our aluminum chassis that dissipates heat five times faster than steel. Or our receptacles with closed relays to deliver low resistance connections. And less heat.

So, choose your chassis. Pick your PDU base and let us turn you on to decreased costs and increased savings. Yeah, we got the power to rack your world.

***“We think the best racks
deserve the best power.”***

Bryan Lowther - Regional Sales Manager



GreatCabinets.com



MODULAR POWER

PLUG INTO THE POWER OF GREAT LAKES.

Technology is improving to save some green, that's cash money and the environment. A Great Lakes PDU will help you do both.



ONE OF OUR SUCCESSFUL SOLUTIONS

One customer using 840 PDUs in a data center wanted to reduce operation expenses—after all, who wouldn't? Based on published values, actual measurements, and CFD analysis, the customer will realize a significant power and monetary savings.

CASE STUDY RESULTS:



\$30,465

is the total annual savings across the entire data center deployment.



28.98 kW

is the total energy savings across the PDU deployment.



10 BTU/HR

is the heat emission of a GLCC PDU (80 BTU less than that of the existing PDU), resulting in extended life of the PDU.

Our PDUs reduce overall power losses and cooling needs while increasing ROI, putting money back in your pocket.

POWER FORWARD...



MODULAR POWER

WE MANAGE POWER BETTER...

Meticulously designed to save you in the long run.



US

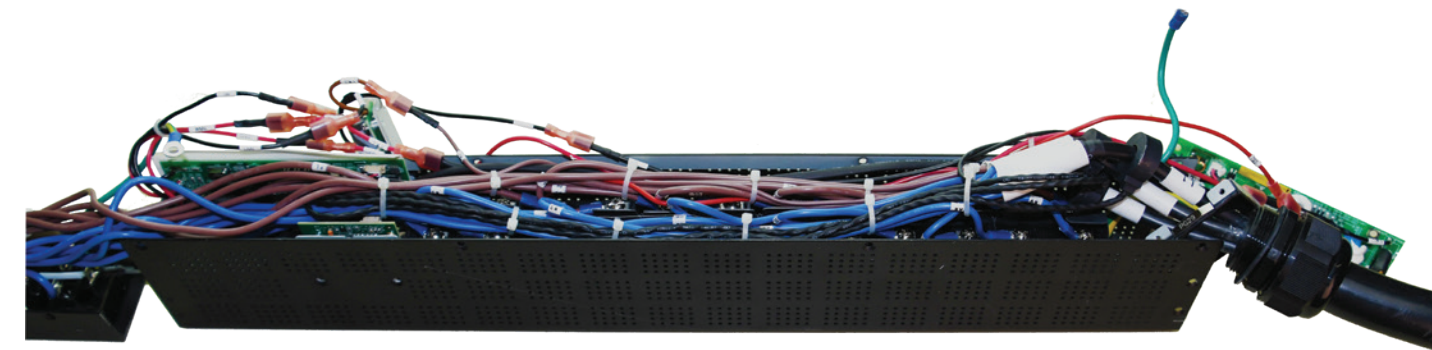

THEM

US VS. THEM

CHASSIS CONSTRUCTION

Aluminum dissipates heat 5 times better than steel

Painted steel traps heat reducing efficiency and lifespan

RELAY

Normally closed relays, which operate at a lower temperature, won't fail open and leave equipment stranded for power

Normally open relays require a power signal to stay turned on, leaving them prone to failure and running hotter

INTERNAL CONNECTIONS

PCB-mounted receptacles are soldered and provide a secure low resistance connection with no power loss or heat generation

Inefficient insulation displacement connections generate heat, waste power, and pose a greater risk for of failure

A LOT BETTER!

Engineered from the inside out with the best construction and materials.



LCD DISPLAY

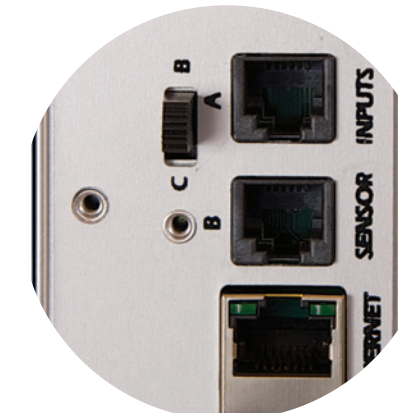

NETWORK PORTS



SECURE CONNECTIONS



LOCKING RECEPTACLES

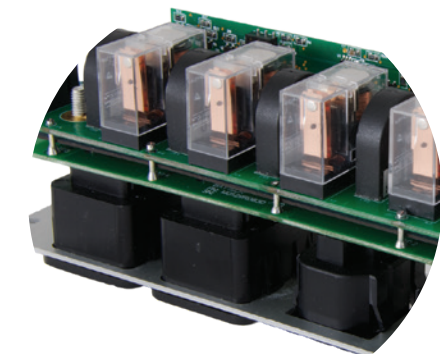

PCB MOUNTED RECEPTACLES

MODULAR POWER

ORDERING IS EASY

1. CHOOSE YOUR CHASSIS

Choose a rack mount or zero-U chassis (requires a PDU bracket to vertically mount). Chassis determines: Footprint; module size and type; number of branch circuits; overall PDU size.



2. CHOOSE YOUR OUTLETS

Number and Type



3. CHOOSE YOUR MONITORING

Choose a level of monitoring: overall PDU, circuit, outlet, switched, or environmental.



DONE!



LET GREAT LAKES INSTALL ANY PDU BEFORE THE CABINET SHIPS!

PLUGS

AMP	VOLT	PLUG TYPE	AMP	VOLT	PLUG TYPE
STRAIGHT-BLADE PLUG			STRAIGHT-BLADE PLUG		
15	125	5-15P	20	250	6-20P
20	125	5-20P			
TWIST-LOCK PLUG			TWIST-LOCK PLUG		
15	125	L5-15P	20	120/208 x 3~ WYE	L21-20P
20	125	L5-20P	20	230/400 x 3~ WYE	L22-20P
30	125	L5-30P	30	120/208 x 3~ WYE	L21-30P
20	250	L6-20P	30	230/400 x 3~ WYE	L22-30P
30	250	L6-30P	30	250 x 3~ DELTA	L15-30P
20	125/250	L14-20P	30	125/250	L14-30P
CALIFORNIA STYLE			CALIFORNIA STYLE		
50	250	2P, 3W	50	250 X 3~ DELTA	3P, W

NEMA

RECEPTACLES

AMP	VOLT	RECEPTACLE TYPE
STRAIGHT-BLADE RECEPTACLES		
20	125	5-20R
TWIST-LOCK RECEPTACLES		
20	125	L5-20R
20	250	L6-20R
30	250	L6-30R

AMP	VOLT	POWER INLET	AMP	VOLT	POWER INLET
15/10*	125 or 250	C-14	20/16*	125 or 250	C-20
PIN & SLEEVE					
20/16*	250/230*	2P, 3W	60/63*	250/230*	2P, 3W
20	250	3P, 4W	60	250	3P, 4W
30/32*	250/320*	2P, 3W	20/16*	230/400* x 3~ WYE	4P, 5W
30	250	3P, 4W	30/32*	230/400* x 3~ WYE	4P, 5W

IEC

AMP	VOLT	POWER RECEPTACLE
15/10*	125 or 250	C-13
20/16*	125 or 250	C-20

*Rating for CE products

CABINET MOUNTING



Part No.	Description	Compatible Cabinet
PDU BRACKETS FOR CABINETS		
ES and EZ cabinets come standard with two sets of PDU brackets, one set installed in each rear corner; standard brackets must be removed to use brackets below		
PSBKES-R-30	Set of two PDU brackets (with 1 mounting position) to vertically mount a single PDU; attaches to FMP of rear face of rail	30/32"W ES sizes
PSBKES-A-3042	Set of two PDU brackets (with 2 mounting positions) to allow angled, vertical mounting of PDU; installs in rear cabinet corner	30"W x 42"D ES
PSBKES-A-3048	Set of two PDU brackets (with 4 mounting positions) to allow angled, vertical mounting of PDU; installs in rear cabinet corner	30"W x 48"D ES
PSBKES-F30	Set of four PDU brackets (with one mounting position) to allow vertical mounting in front cabinet corners	30"W ES
PSBKE	Set of two PDU brackets to vertically mount single PDU; installs in rear cabinet corner (not pictured)	All E sizes

RACK MOUNTING



Part No.	Description	Compatible Rack
PDU BRACKETS FOR RACKS		
PDU2ER	Set of two PDU brackets (with 2 mounting positions) to vertically mount PDUs; installs to FMP on side of rack channels	CMRX, CMR, VRX
PDU3ER	Set of two PDU brackets (with 3 mounting positions) to vertically mount PDUs; installs to FMP on side of rack channels	CMRX, CMR, VRX
VPCB1	Vertical power/cable bar with keyhole pattern to vertically mount a single PDU	CMRX, CMR, VRX
PSBGLRR	Set of two brackets to vertically mount a single standard power strip; installs on rail EIA pattern (not pictured)	4P, GLRR (2P)

STANDARD POWER

Part No. Description

STANDARD POWER STRIPS, VERTICAL MOUNTING

UL Listed; 15' cord

Note: 15 amp, derated 12 amp; 20 amp, derated 16 amp; 30 amp, derated 24 amp

7215	16 receptacles, 5-15R receptacle, 5-15P, 15 amp, 125V
7215-S	16 receptacles, 5-15R receptacle, 5-15P, 15 amp, 125V, surge suppressor
7215-20ARTLP	16 receptacles, 5-20R receptacle, L5-20P, 20 amp, 125V
7215-20AR	16 receptacles, 5-20R receptacle, 5-20P, 20 amp, 125V
7215-30A	24 receptacles, 5-20R receptacle, L5-30P, 30 amp, 125V
7218-24	8 receptacles, 5-15R receptacle, 5-15P, 15 amp, 125V

Part No. Description

STANDARD POWER STRIPS, 19" MOUNTING

UL Listed, 15' cord; Note: 15 amp, derated 12 amp; 20 amp, derated 16 amp

7219	6 receptacles, 5-15R receptacle, 5-15P plug, 15 amp, 125V
7219-SR14	6 front/8 back receptacles, 5-15R receptacle, 5-15P plug, 15 amp, 125V, surge suppressor
7219-20AR	6 receptacles, 5-20R receptacle, 5-20P plug, 20 amp, 125V
7219-20ARTLP	6 receptacles, 5-20R, L5-20P plug, 20 amp, 125V

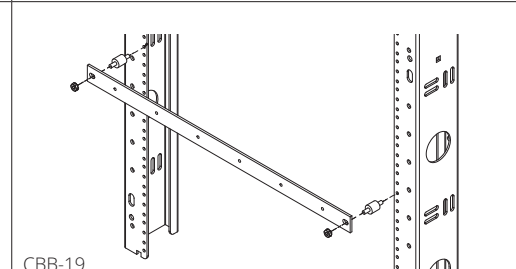
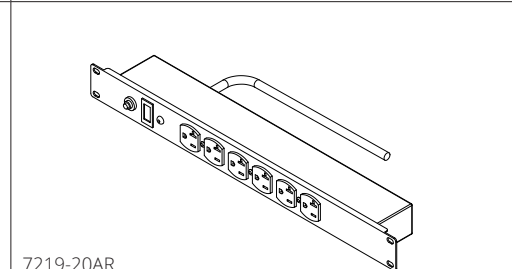
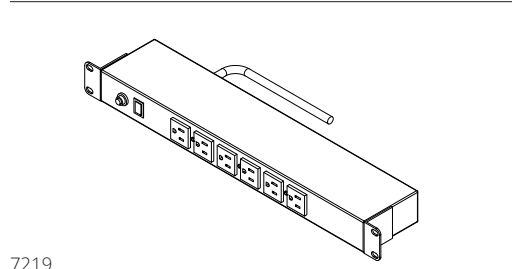
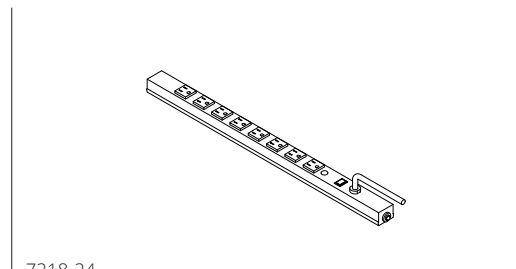
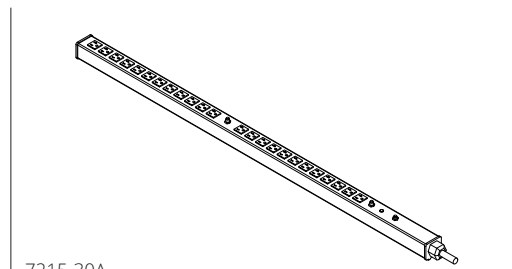
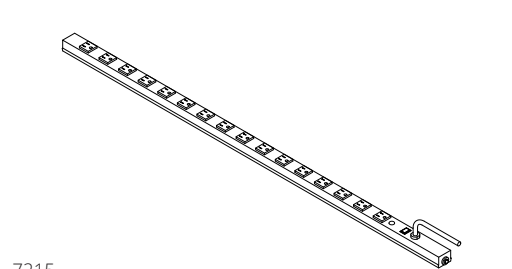

Part No. Description

COPPER BUS BARS

Isolated copper bus bars

CBB-19	19" mounting
CBB-30	25"L bar
CBB-48	43.5"L bar
CBB-60	58"L bar
CBB-72	66"L bar
CBB-78	76"L bar

We rack your world.

ADD IT ON.

When we say it's your choice, we mean it. All the way down to the type of hardware that you use.

So accessorize away. From 19" cable organizers to filler panels to power strips and bus bars. We'll install it where you tell us. The same 19" accessories work with cabinets, wall mounts, and racks. There's not even a charge for us to install it. That's part of our fast, flexible, and easy story.

And this is the good stuff. Really high quality. Made in America like all our products. Even with accessories, we rack your world.

"Every job is different, but our ability to customize makes it easy."

Carrie Hammond - Inside Sales



GreatCabinets.com

CABLE ORGANIZERS

Part No.	Description
HORIZONTAL CABLE ORGANIZERS	
CM-04	Horizontal cable organizer with five 3.5" x 5" 1/4 turn "D" rings (metal panel with plastic rings), 2 RMU
CM-05	Horizontal cable organizer with five 1.5" x 3.5" 1/4 turn "D" rings (metal panel with plastic rings), 1 RMU
CM-07	Horizontal waterfall cable organizer (metal), 1 RMU
CM-09	Double-sided, horizontal cable organizer, four front horizontal and five rear vertical rings, 1.3"W x 2.8"D (metal), 1 RMU
CM-15	Double-sided, horizontal cable organizer with fingers and covers; front channel, 3" x 3"; rear channel 1.5" x 3" (plastic); 2 RMU required for mounting
CM-16	Single-sided, horizontal cable organizer with fingers and cover (plastic), 1 RMU
CM-17	Single-sided, horizontal cable organizer with fingers and covers (plastic), 2 RMU

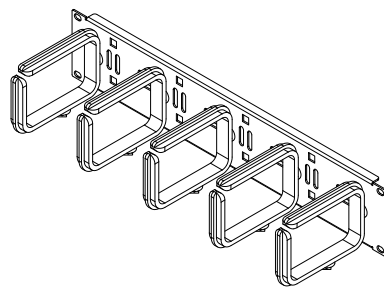

CM-04

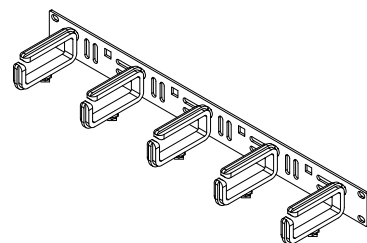

CM-05

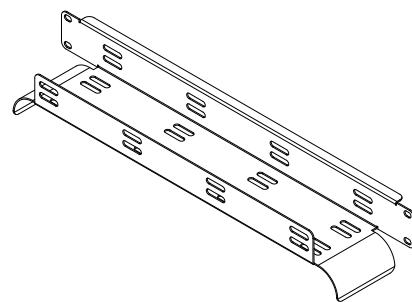

CM-07

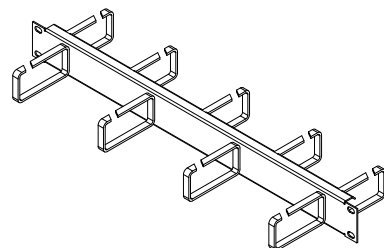

CM-09

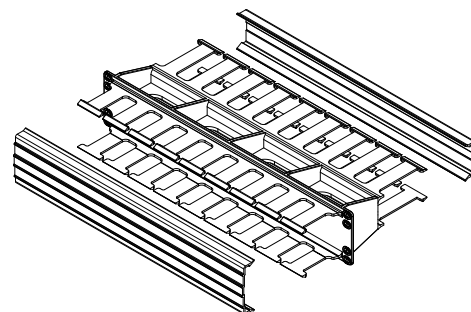

CM-15

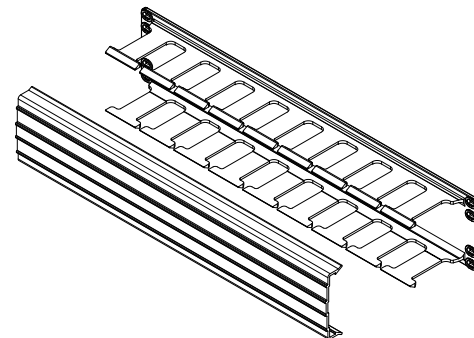

CM-17

SHELVES

Part No.	Description
STATIONARY SHELVES	
7206-BT	17" x 20.75"; weight capacity 300 lbs.; 3 RMU; max tab placement 25.25"
7206-FM	17.25"W x 18"D; weight capacity 60 lbs.; 2 RMU
7206-EIA	17.5"W x 18"D; weight capacity 80 lbs.; 2 RMU
7206-14	17.5"w x 14"D; weight capacity 80 lbs.; 2 RMU
7206-FR-A18	17.5"W x 18"D; weight capacity 150 lbs.; 1 RMU; max tab placement 21.5"
7206-FR-AHD	17.5"W x 22.25"D; weight capacity 200 lbs.; 1 RMU; max tab placement 26.125"
7206-FR-ADHD	17.5"W x 27.25"D; weight capacity 150 lbs.; 1 RMU; max tab placement 32.25"
7206-FR-A28HD	17.5"W x 28"D; weight capacity 300 lbs.; 1 RMU; max tab placement 30.18"
7206-FR-A32HD	17.5"W x 32"D; weight capacity 300 lbs.; 1 RMU; max tab placement 36"

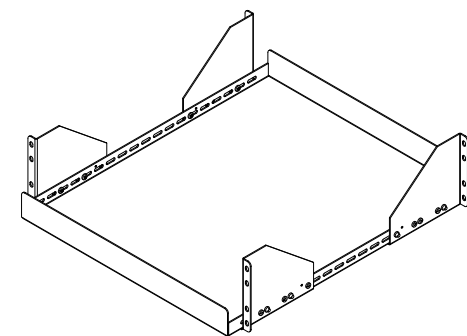

7206-BT

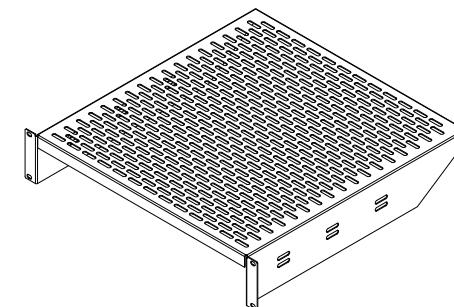

7206-FM

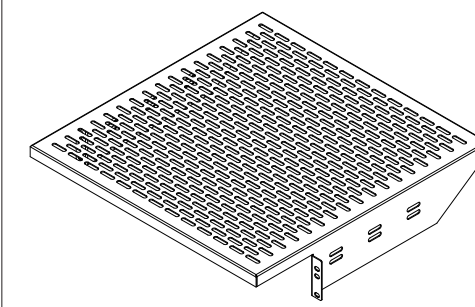

7206-EIA

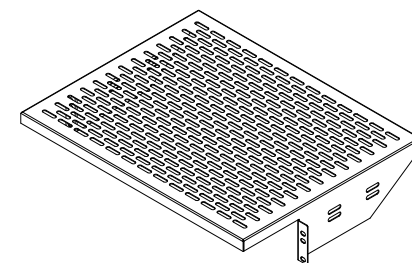

7206-14

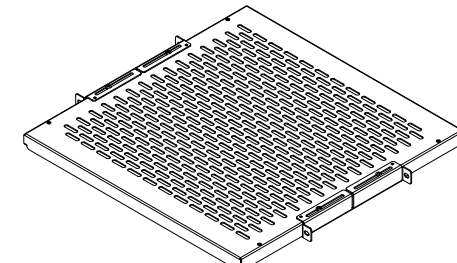

7206-FR

SHELVES

Part No.	Description
SLIDING SHELVES	
7206-SL	16.343"W x 17.5"D; weight capacity 40 lbs.; 3 RMU
7206-FRSL-AHD	17.5"W x 22"D; weight capacity 110 lbs.; 2 RMU; max tab placement 26.125"
7206-FRSL-ADHD	17.5"W x 26"D; weight capacity 110 lbs.; 2 RMU; max tab placement 32.125"
7206-FRSLA300	14.33"W x 30"D; weight capacity 300 lbs.; 2 RMU; max tab placement 36.12"
SPECIALTY SHELVES	
7206-PKB-MT	Sliding keyboard, mouse shelf; 20.625"W x 9.5"D; weight capacity 110 lbs.; 3 RMU, max tab placement 36.12"
7206-MKM	Monitor; keyboard, mouse shelf; 17"W x 24"D; weight capacity 200 lbs.; 2 RMU max tab placement 36.12"
7206-DR	Pull-out drawer; 16"W x 18.875"D; weight capacity 100 lbs.; 4 RMU; max tab placement 25.50"

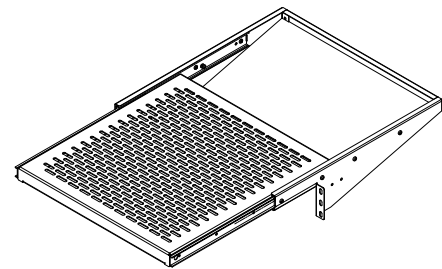

7206-SL

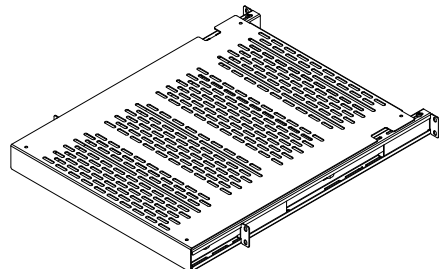

7206-FRSL

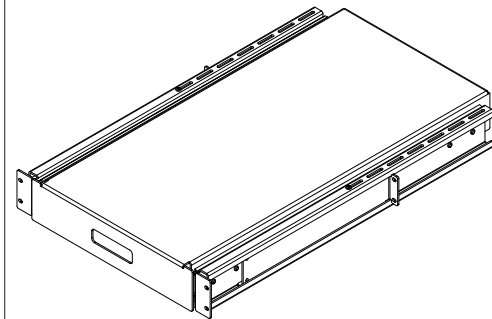

7206-FRSLA300

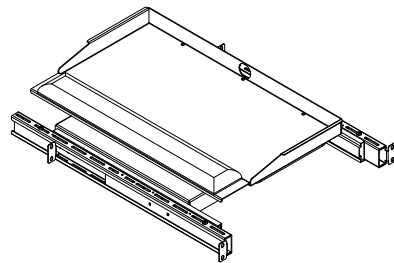

7206-PKB-MT

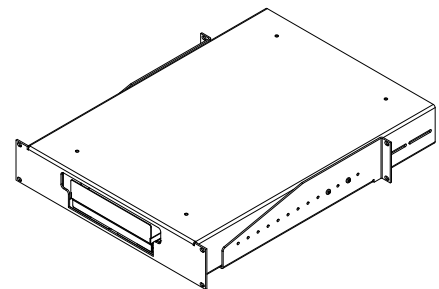

7206-MKM

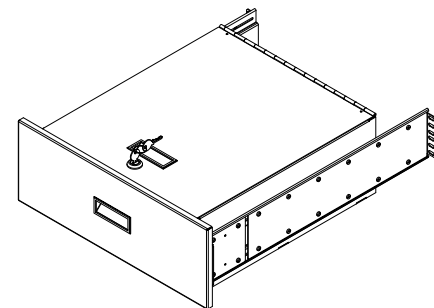

7206-DR

STANDARD POWER

Part No.	Description
POWER STRIPS & BUS BAR FOR 19" MOUNTING	
7219	6 position power strip, 15 amp, 125 Volt, 5-15R receptacle and 5-15P plug
7219-SR14	14 position (6 front/8 back) power strip with surge protector, 15 amp, 125 Volt, 5-15R receptacle and 5-15P plug
7219-20AR	6 position power strip, 20 amp, 125 Volt, 5-20R receptacle and 5-20P plug
7219-20ARTLP	6 position power strip, 20 amp, 125 Volt, 5-20R receptacle and L5-20P plug
CBB-19	Copper bus bar, isolated

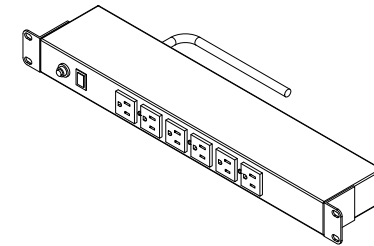

7219

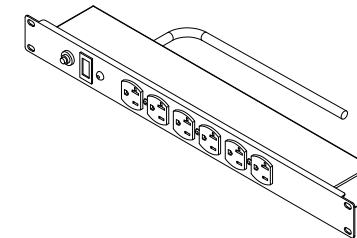

7219-20AR

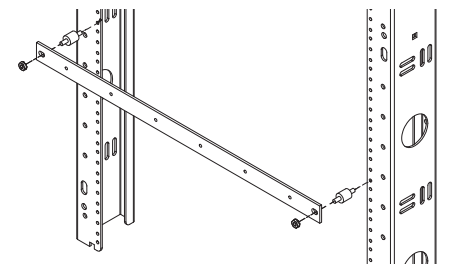

CBB-19

FILLER PANELS

Part No.	Description
----------	-------------

TOOL-LESS METAL FILLER PANELS FOR 19" MOUNTING, FOR USE WITH 3/8" SQ. (M6) RAILS

1.75-FPTL19	1 RMU, 1.75"H
3.50-FPTL19	2 RMU, 3.5"H
5.25-FPTL19	3 RMU, 5.25"H
7.00-FPTL19	4 RMU, 7.0"H
8.75-FPTL19	5 RMU, 8.75"H
14.00-FPTL19	8 RMU, 14.0"H

METAL FILLER PANELS FOR 19" MOUNTING

1.75-FP19	1 RMU, 1.75"H
3.50-FP19	2 RMU, 3.5"H
5.25-FP19	3 RMU, 5.25"H
7.00-FP19	4 RMU, 7.0"H
8.75-FP19	5 RMU, 8.75"H
14.00-FP19	8 RMU, 14.0"H

PLASTIC SNAP-IN FILLER PANELS FOR 19" MOUNTING

GLHL10031CP	1 RMU, black panels, pack of 10
GLHL10114CP	1 RMU, white panels, pack of 10
GLHL10035CP	1 RMU, black panels with temp. strip, pack of 10
GLHL10033CP	2 RMU, black panels, pack of 5
GLHL10115CP	2 RMU, white panels, pack of 5
GLHL10038CP	2 RMU, black panels with temp. strip, pack of 5
GLHL10009CP	Adhesive temperature strip, pack of 10

FILLER PANEL WITH BRUSH GROMMET FOR 19" MOUNTING

1.75FP19BG	1 RMU with brush to allow cable pass-thru
3.50FP19BG	2 RMU with brush to allow cable pass-thru

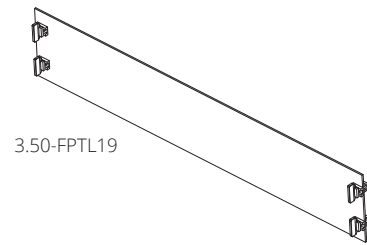

3.50-FPTL19

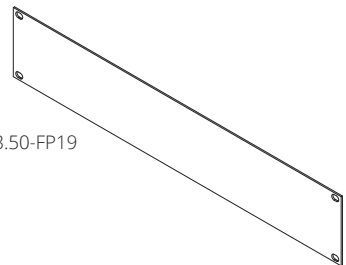

3.50-FP19

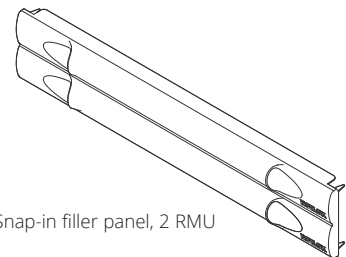

Snap-in filler panel, 2 RMU

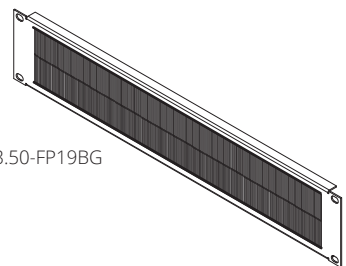

3.50-FP19BG

POLICIES

PRODUCT WARRANTY

Great Lakes Data Racks & Cabinets warrants that each of its standard products is free from defects in material and workmanship for a period of one year from date of shipment. If within that period of time, goods shall be determined defective, these goods should be replaced or repaired at Great Lakes' option. Under no circumstances, however, will Great Lakes be held responsible for any amount beyond the price of the product or any unauthorized "field" repair. Such correction or replacement of defective goods shall constitute a fulfillment of all liabilities in respect to such goods. Electrical components provided by Great Lakes are warranted for a period of one year from date of purchase. This applies to all power strips, fan assemblies and blower units. THIS EXPRESS WARRANTY IS IN LIEU OF AND EXCLUDES ALL OTHER WARRANTIES, WHETHER EXPRESS OR IMPLIED, INCLUDING BUT NOT LIMITED TO THE IMPLIED WARRANTIES OF MERCHANTABILITY OR FITNESS FOR A PARTICULAR PURPOSE.

EXCLUDED PRODUCTS: Some products in this catalog are not manufactured by us and are not covered by our limited warranty. Please contact our sales staff to obtain information about manufacturer warranties and terms (which may not be assignable).

CONDITIONS & EXCEPTIONS

Our products must be handled, installed and shipped according to industry standards for metal fabrication and solid state electronic equipment. Claims under this policy must be made by the original purchaser.

All damages must be reported to Great Lakes within 72 hours after receipt of product. Claims beyond this time period will not be the responsibility of Great Lakes. Any indentations, punctures, or other damages to the shipping cartons should be noted by receiving personnel on the delivery report. This will help protect our customers from possible concealed damages (Applies only to Prepay and Add freight option with carrier specified by Great Lakes).

REPAIR AND RETURN PROCEDURES

Products being returned for repair or replacement must have prior approval and an assigned RMA (Return Merchandise Authorization) number. The RMA number must appear on all packages, which should be shipped collect to:

Great Lakes Data Racks & Cabinets
4193 Route 6N East
Edinboro, PA 16412
RMA No. _____

Products being returned due to reasons other than normal repair or replacement will be subject to a 20% restocking charge. This charge is based on invoice prices. The restocking charge does not release the customer from the responsibility of proper packaging and return of the product in reusable condition. Products held by customer in excess of 30 days may not be returned for credit. The return must have an RMA assigned and are the responsibility of the customer to return to Great Lakes.

Note: Any special customized cabinets or cases must first be approved in writing by the customer. Once the customer approves and receives the special unit, there will be no return of such product except for modifications or repair of damages.

PAYMENT TERMS

Net 30 day accounts will be opened only after approval of credit. On approved accounts: net 30 days from date of invoice. Past due accounts are subject to a 1.5% late charge for each 30 days period the outstanding balance remains unpaid beyond the 30th day after invoice date. Past due accounts beyond 60 days are subject to credit hold. Terms and conditions may not apply to delivery outside the United States and in the European Economic Community. Please contact your Great Lakes Representative for details.

FREIGHT HANDLING OPTIONS

1. Great Lakes Prepay & Add: (Carrier specified by Great Lakes) Great Lakes pays freight charges to the carrier and adds freight charge costs to the product invoice. Great Lakes offers this service without an additional handling charge; provided the customer agrees to the following conditions:

- A. Carrier is specified by Great Lakes. Great Lakes has contractual agreements with selected carriers to minimize shipping costs.
- B. Customer agrees to pay Great Lakes all freight charges appearing on product invoices without requiring additional freight cost documentation.
- C. Customer agrees to pay Great Lakes for freight costs associated with an order shipment, but not contained in the initial product invoice. (Great Lakes will provide a separate invoice for this cost.) *Example:* an additional cost from the carrier for inside delivery service required by the end user and not specified on the purchase order.
- D. Agreement to these conditions is implied when customer specifies prepaid freight when placing an order with Great Lakes.
- E. Great Lakes reserves the right to withdraw the prepaid option at any time.

2. Third Party Billing: (Carrier specified by Customer) Freight is billed to a party other than Great Lakes or the Customer. A third party account number or third party billing address is supplied by the Customer.

3. Freight Collect: (Carrier specified by Customer) A freight account number is supplied or freight charges are paid by check at the destination site upon delivery.

We rack your world.

POLICIES

DAMAGES

1. Prepay and Add Freight:
(Carrier chosen by Great Lakes)
 - A. Great Lakes is responsible for adding freight charges to product invoice and freight claims.
 - B. Great Lakes has the option to supply replacement parts, if needed.
 - C. Great Lakes has the option to have damaged product returned to Great Lakes.
2. Third Party Billing:
(Carrier chosen by Customer)
 - A. Third party customer is responsible for all freight charges and for filing all freight claims with the freight carrier.
 - B. All replacement parts must be ordered with a new purchase order.
3. Freight Collect: (Carrier chosen by Customer)
 - A. Collect customer is responsible for all freight charges.
 - B. All replacement parts must be ordered with a new purchase order.

FREIGHT ESTIMATES

If requested, Great Lakes will provide freight estimates. Great Lakes will not be liable for the accuracy of these estimates. Great Lakes does not guarantee transit times, either verbal or inferred. These are estimates and should be treated as such. Great Lakes reserves the right to discontinue its freight estimate program at any time. All weights shown are approximate and obtained from standard packaging procedures. Skid weight is not included.

INSIDE DELIVERY

A single driver taking a carton or skid from the receiving area to the desired room or office. The driver must be provided an adequate loading dock for off loading and an unobstructed path to the room or office to which the carton or skid is destined. The driver will provide any necessary equipment required for easier handling, such as a hand truck or pallet jack. If the final destination is not accessible from the loading dock, a freight elevator must be provided.

Note: Drivers are not permitted to unpack or remove cartons.

LIFTGATE SERVICE

A liftgate is a small platform installed at the rear of some delivery trucks used to lower heavy or bulky freight to ground level when no loading dock is available. Any customer that cannot provide an adequate loading dock should request a liftgate service when ordering. Liftgate service only delivers the carton or skid to ground level and does not provide delivery anywhere but inside the customer's door. Liftgate service is not included under the definition of inside delivery. It is a separate service charge which must be pre-arranged before delivery.

Note: Not all trucks are equipped with a liftgate.

NOTIFICATION

Most carriers will charge a fee anytime they are required to call and arrange an appointment before delivery.

Note: Great Lakes requires customers to provide a reliable contact name and phone number for someone at the destination site to eliminate any confusion about location, time of delivery, and services required beforehand.

RECONSIGNMENT

Any change from the original delivery destination after the product has left the shipper's loading dock results in a reconsignment fee. As a reconsignment fee can nearly match the original dock-to-dock freight charges, it is in the customer's best interest to be absolutely certain of the delivery destination.

REDELIVERY

Whenever a delivery is refused by a customer (for reasons that are not the fault of the carrier) and must subsequently be redelivered to the same site, the carrier will charge a redelivery fee.

NON-STANDARD LEAD-TIME

Lead-time is 6 weeks after receipt of signed approval drawings. *Note: approval drawings will be produced after receipt of a purchase order.* Actual lead-time may vary due to availability of parts, items or material required to produce ordered item.

COMPANY INFORMATION

ISO 9001:2015 Registered
Self certified small business
WBENC Certified: 246037
CAGE Code: OYN12
DUNS Number: 153783022

Product specification, price and availability are subject to change without prior notice. Please contact us at our Corporate Headquarters to verify orders. Great Lakes Data Racks & Cabinets is not responsible for typographical errors. Terms and conditions may not apply to delivery outside the United States and in the European Economic Community. Please contact your Great Lakes Representative for details.

GLOBAL PRESENCE — HOMETOWN SERVICE



North America — Edinboro, PA • Reno, NV • Naples, FL • Corry, PA | 1.866.879.4522
Europe — Dublin, Ireland • Budapest, Hungary | + 353 1 825 8777

GreatCabinets.com

©2020 Great Lakes Data Racks & Cabinets. All rights reserved. MKCREV1